

Database System Architecture

Index Structures

Hector Garcia-Molina
Stijn Vansummeren

Index structure

- Any data structure that takes as input a search key and ***efficiently*** returns the collection of matching records

Sequential File

10	
20	

30	
40	

50	
60	

70	
80	

90	
100	

Dense Index

Sequential File

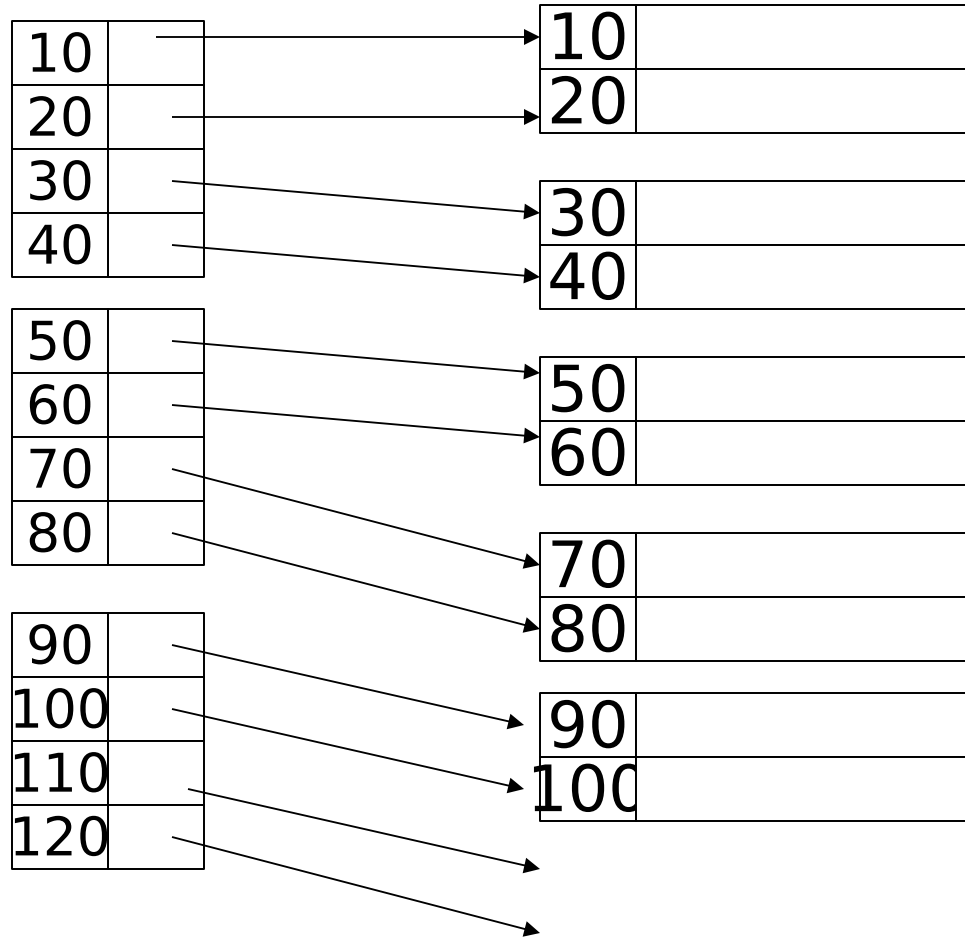

Sparse Index

Sequential File

10	
30	
50	
70	

90	
110	
130	
150	

170	
190	
210	
230	

10	
20	

30	
40	

50	
60	

70	
80	

90	
100	

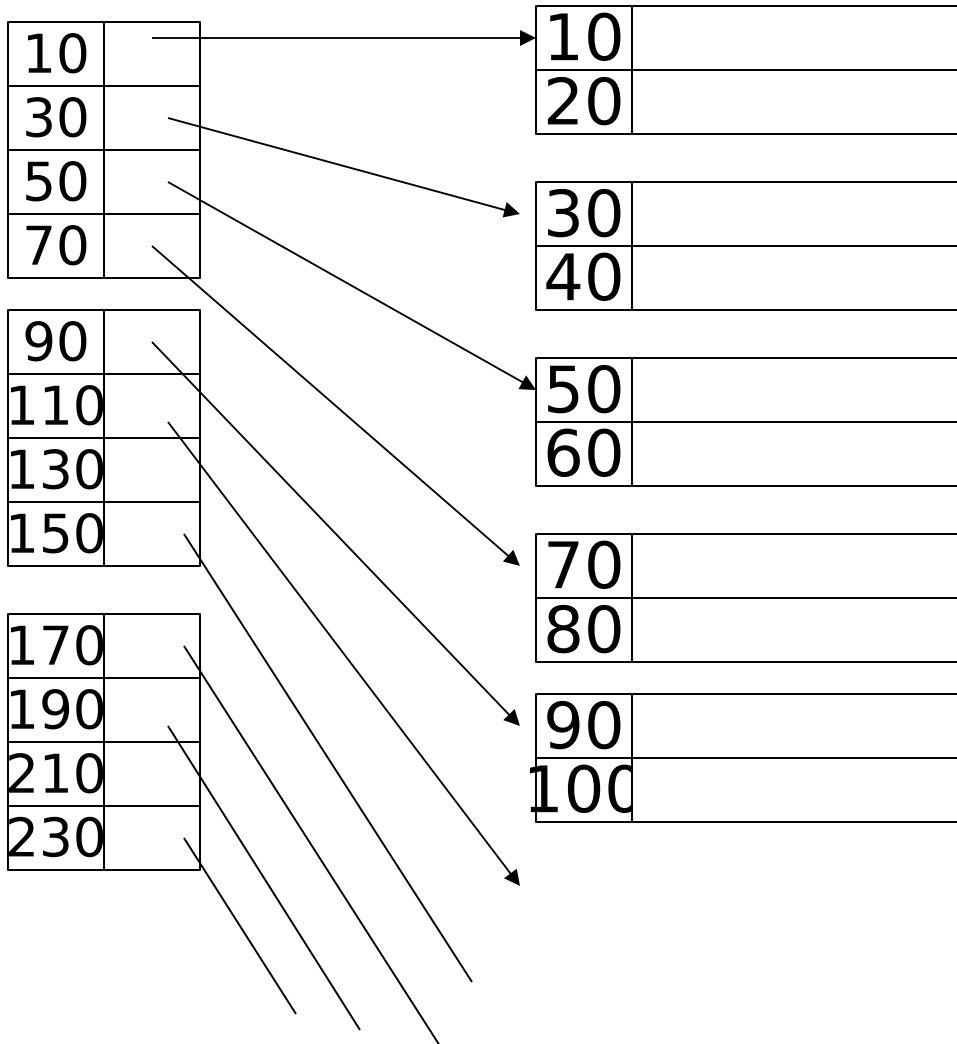

Sparse 2nd level

Sequential File

10	
90	
170	
250	

330	
410	
490	
570	

10	
30	
50	
70	

90	
110	
130	
150	

170	
190	
210	
230	

10	
20	

30	
40	

50	
60	

70	
80	

90	
100	

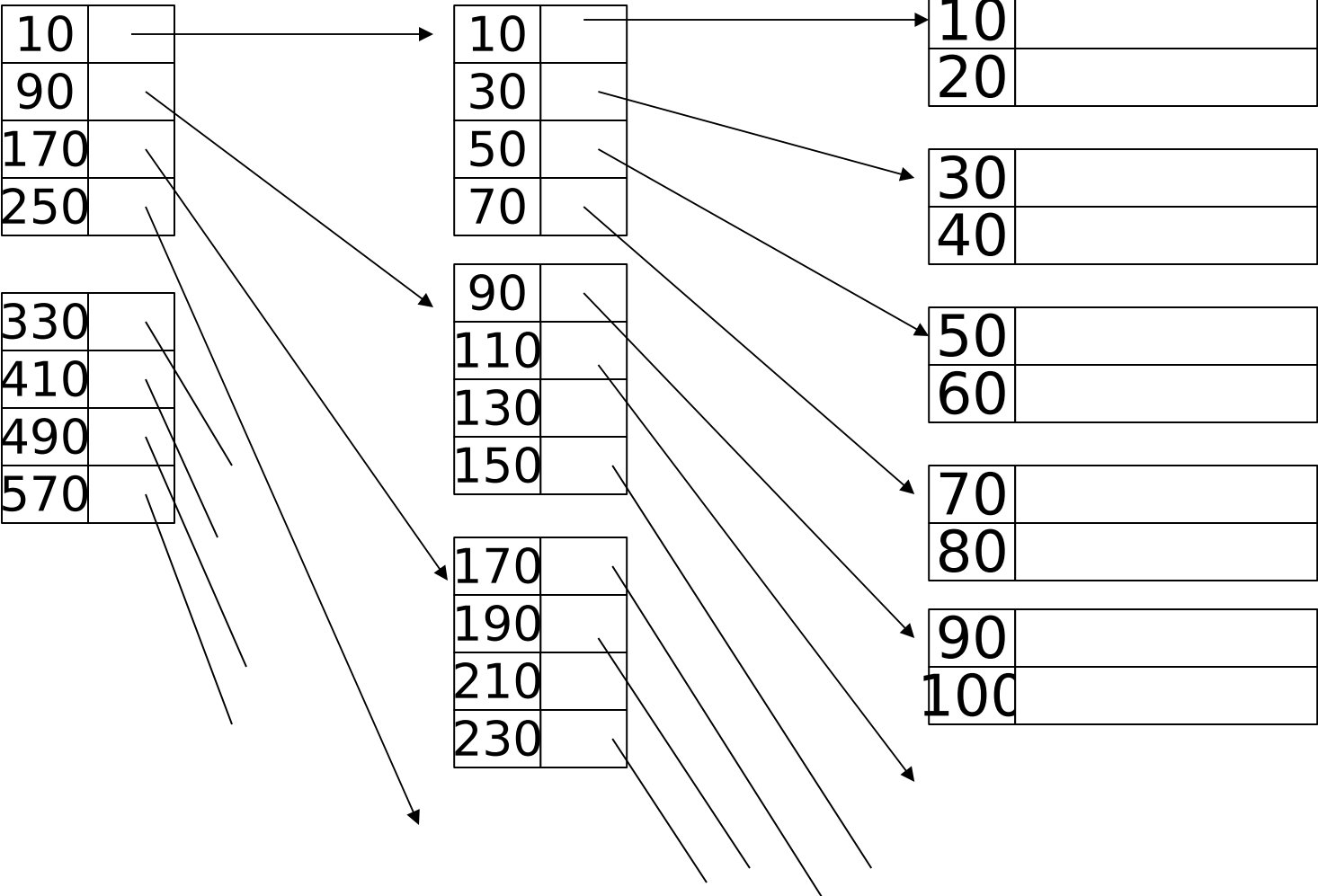

Question:

- Can we build a dense, 2nd level index for a dense index?

Sparse vs. Dense Tradeoff

- Sparse: Less index space per record
can keep more of index in
memory
- Dense: Can tell if any record exists
without accessing file

(Later:

- sparse better for insertions
- dense needed for secondary indexes)

Next:

- Duplicate keys
- Deletion/Insertion
- Secondary indexes

Duplicate keys

10	
10	

10	
20	

20	
30	

30	
30	

40	
45	

Duplicate keys

Dense index, one way to implement?

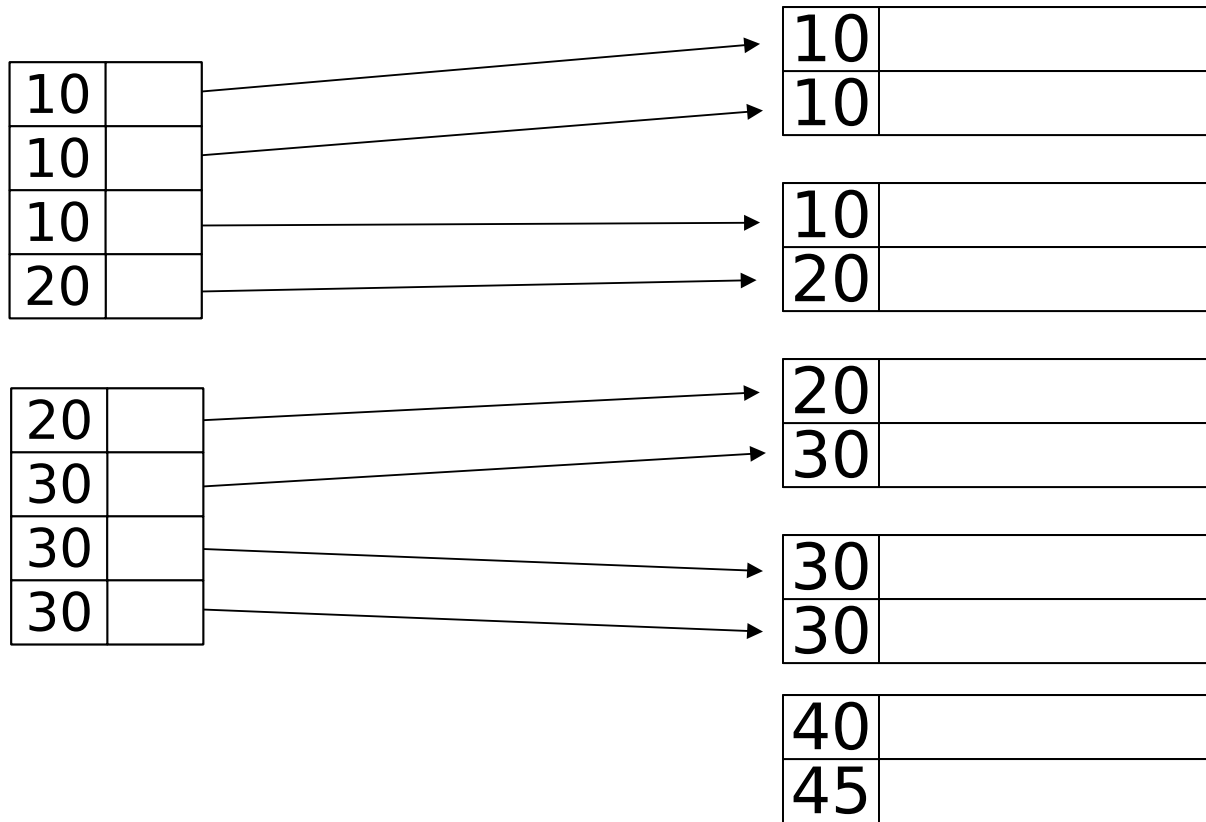

Duplicate keys

Dense index, better way?

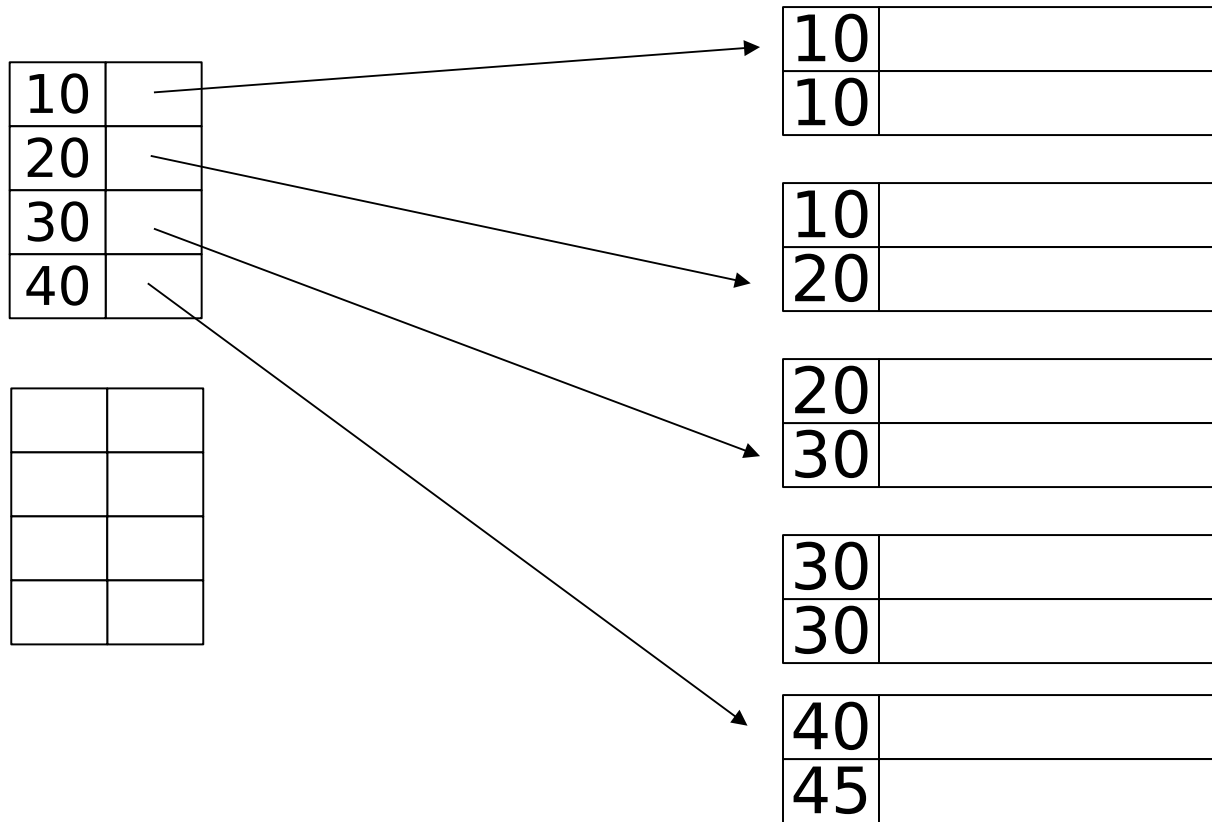

Duplicate keys

Sparse index, one way?

careful if looking
for 20 or 30!

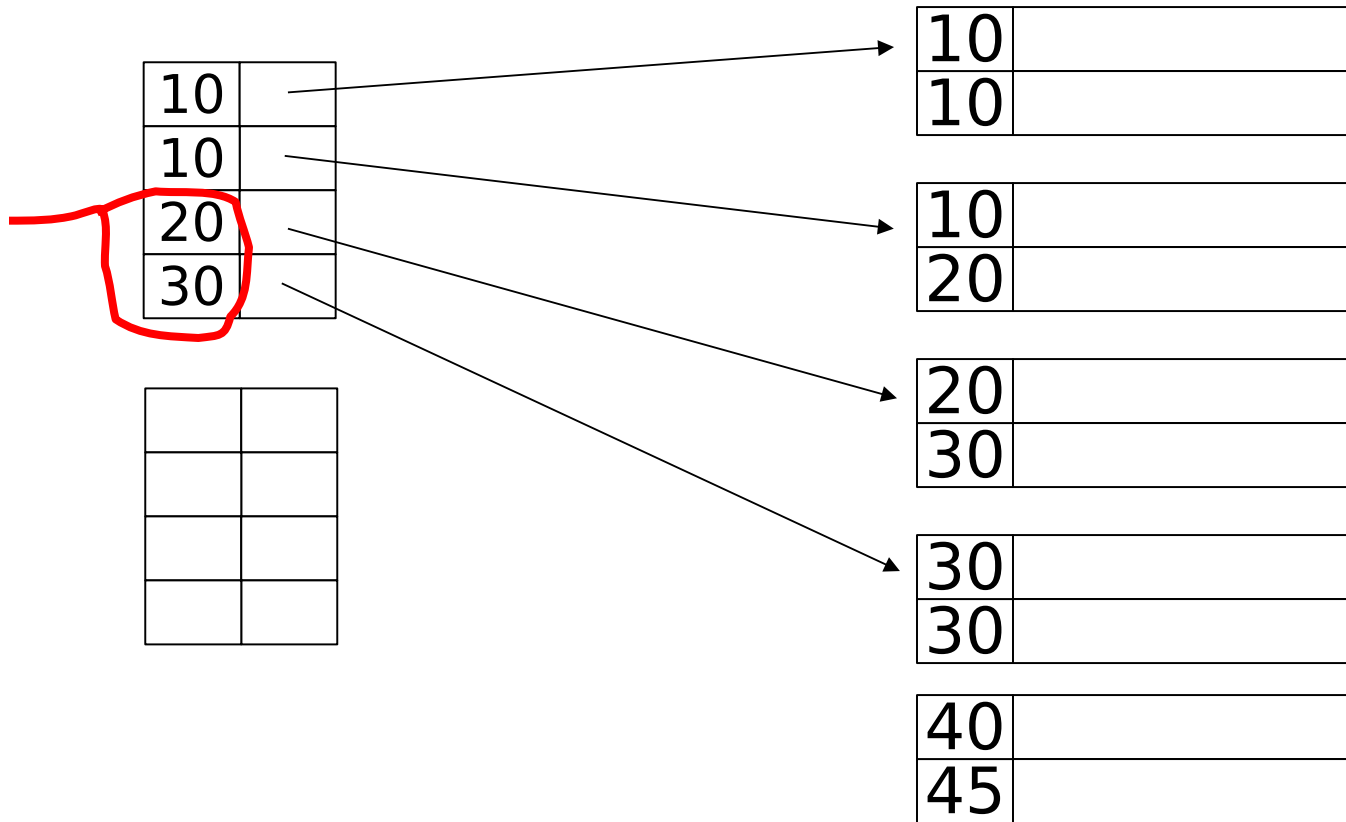

Duplicate keys

Sparse index, another way?

place first new key from block

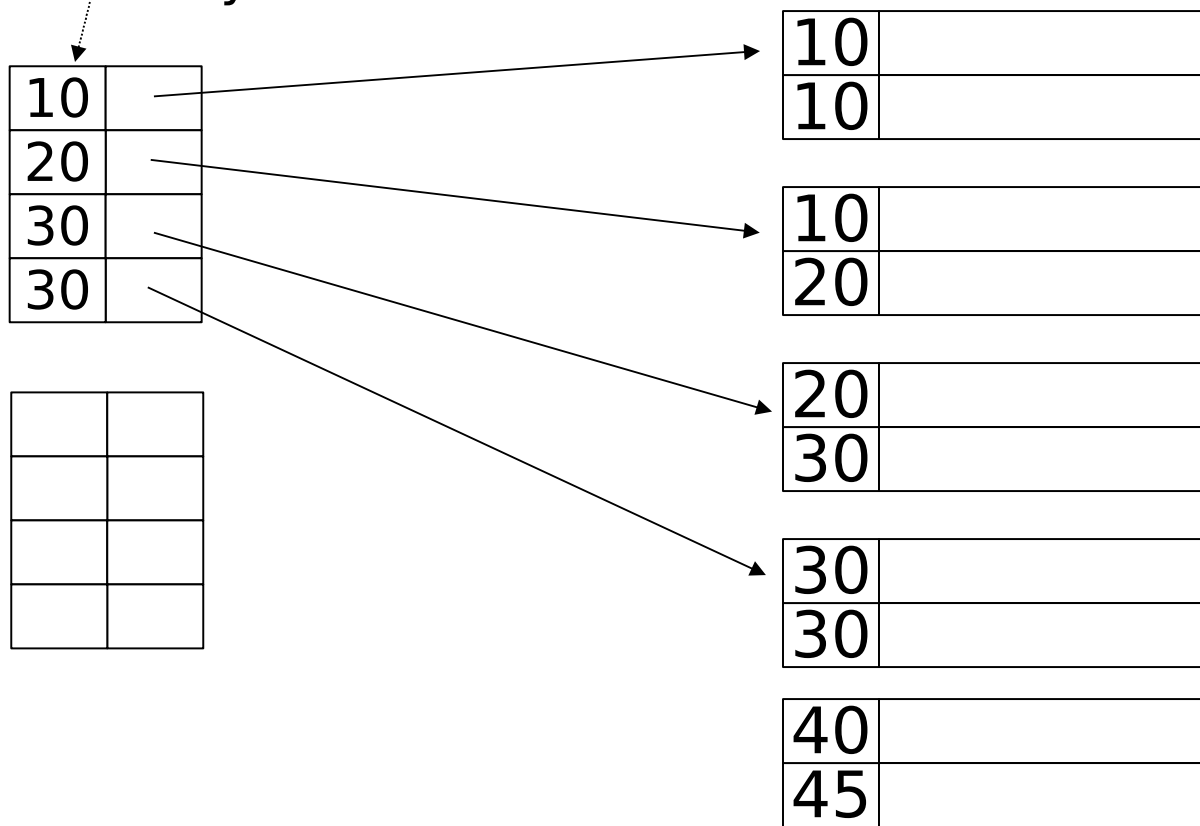

Deletion from sparse index

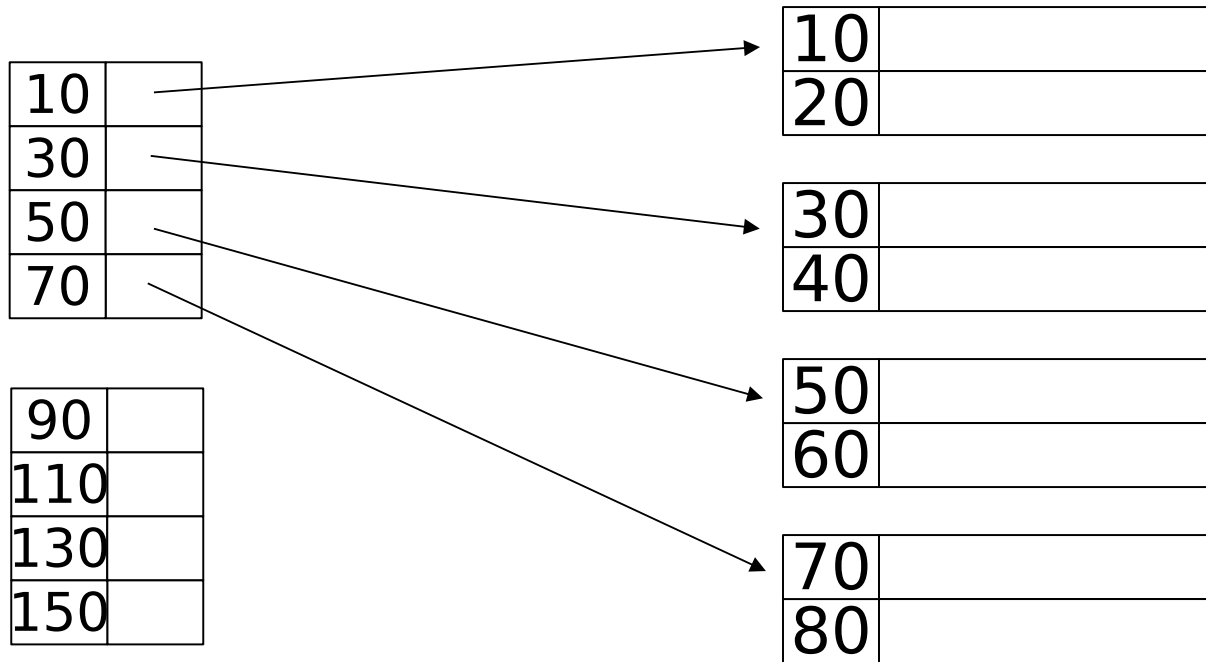

Deletion from sparse index

- delete record 40

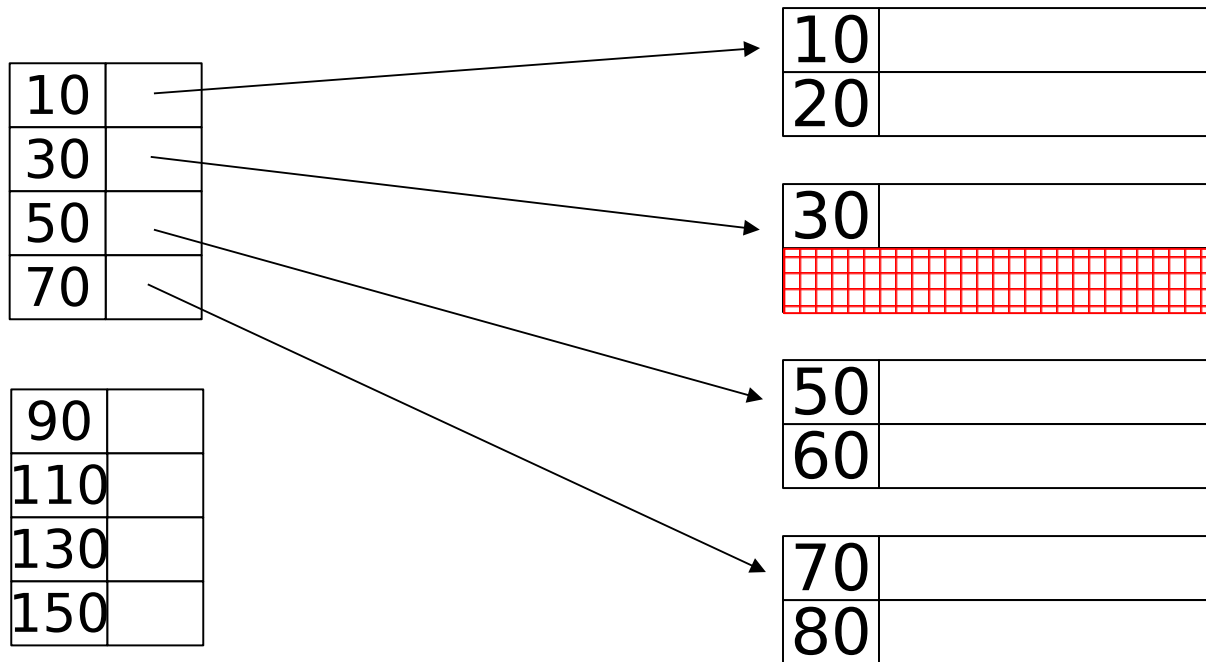

Deletion from sparse index

- delete record 30

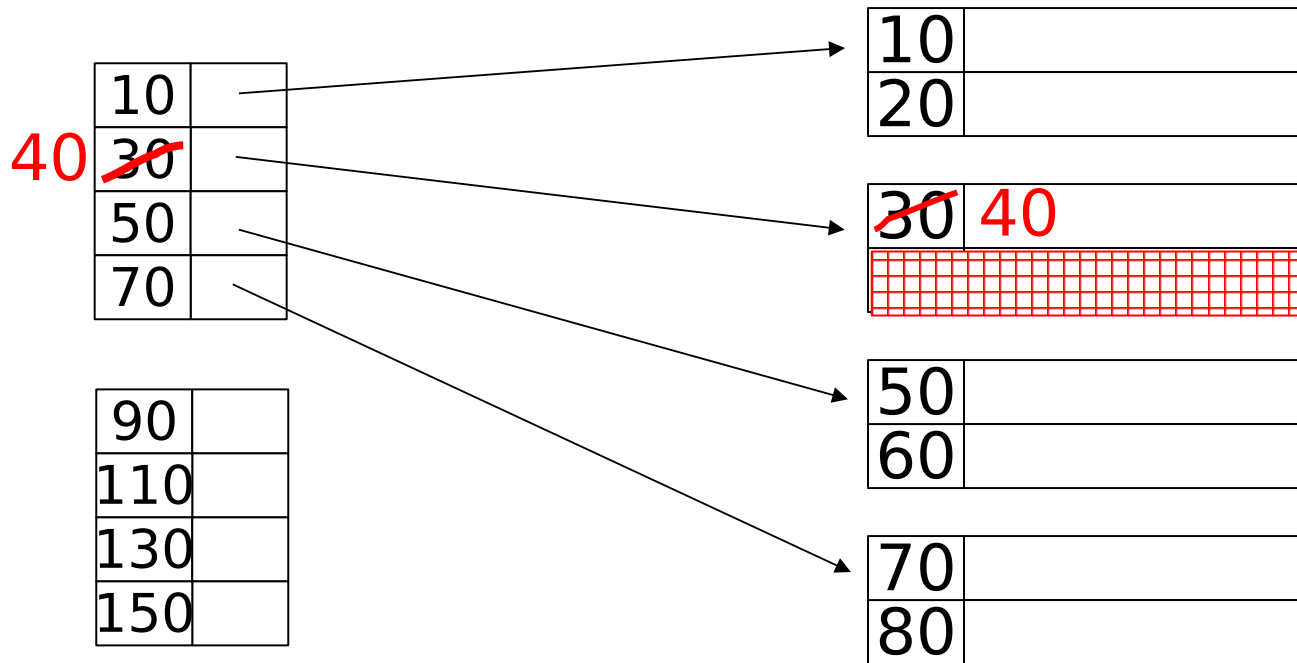

Deletion from sparse index

- delete records 30 & 40

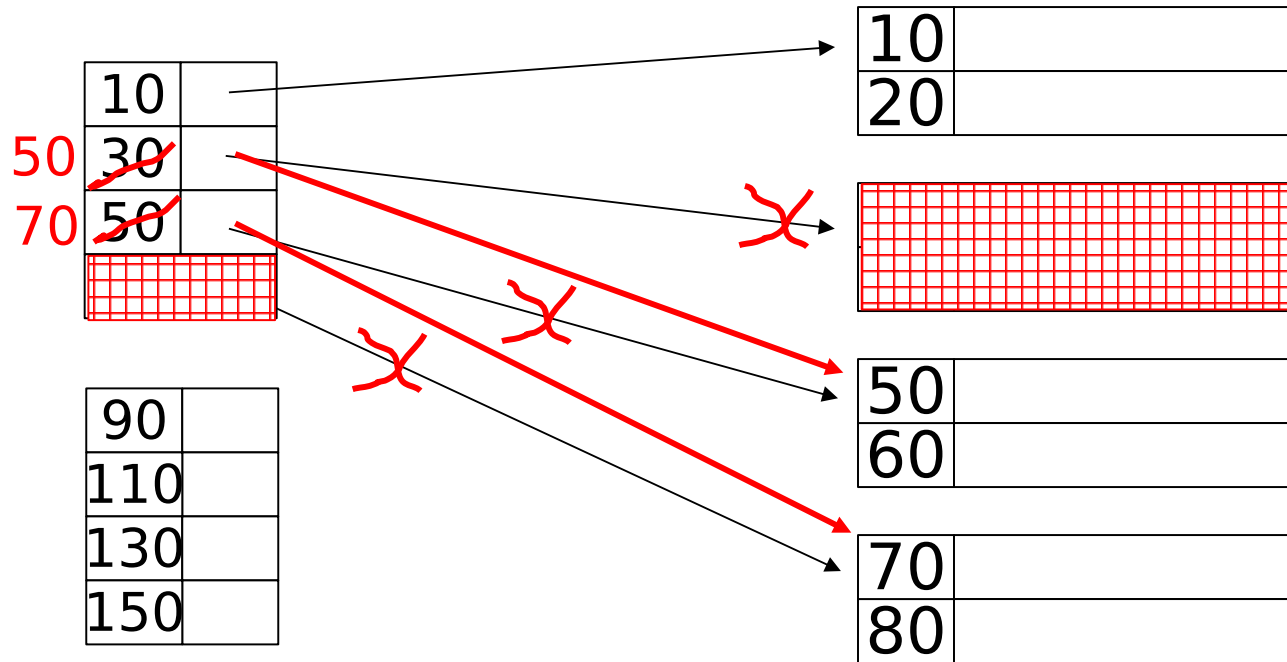

Deletion from dense index

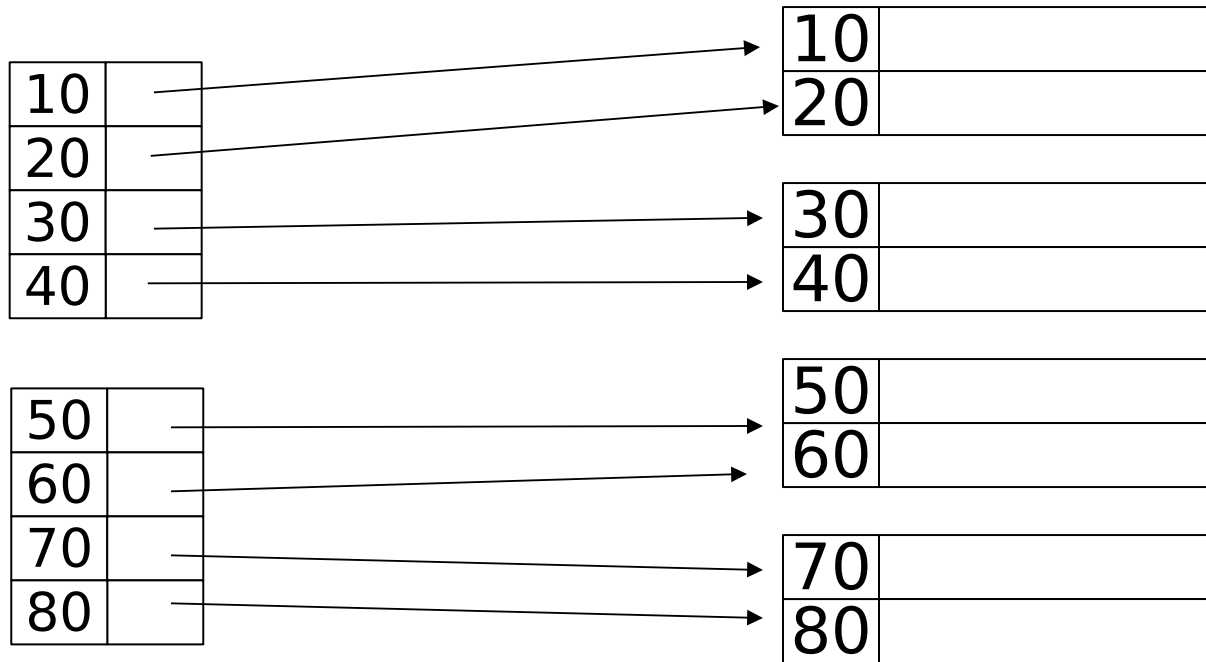

Deletion from dense index

- delete record 30

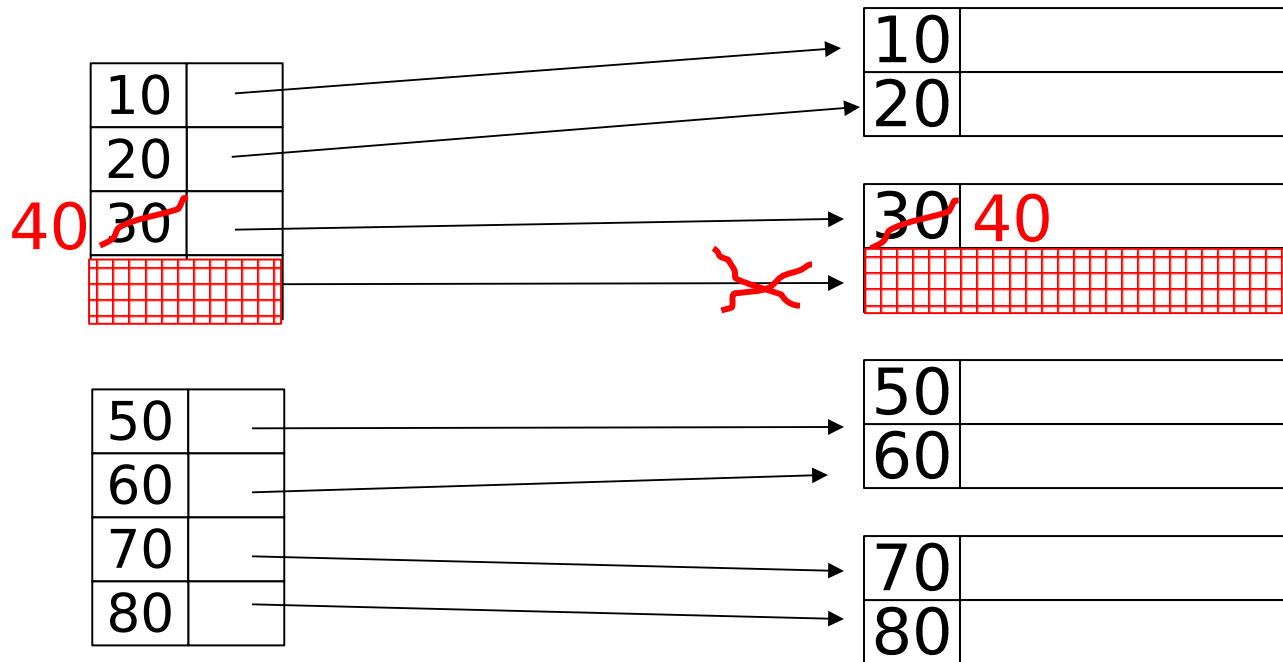

Insertion, sparse index case

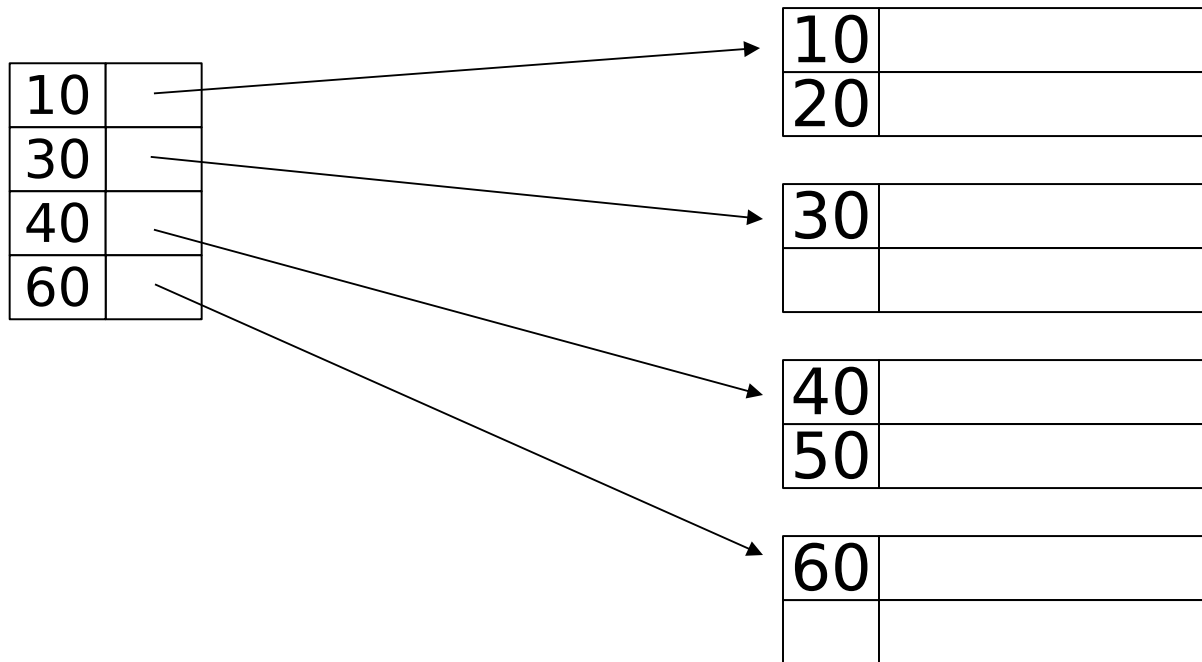

Insertion, sparse index case

- insert record 34

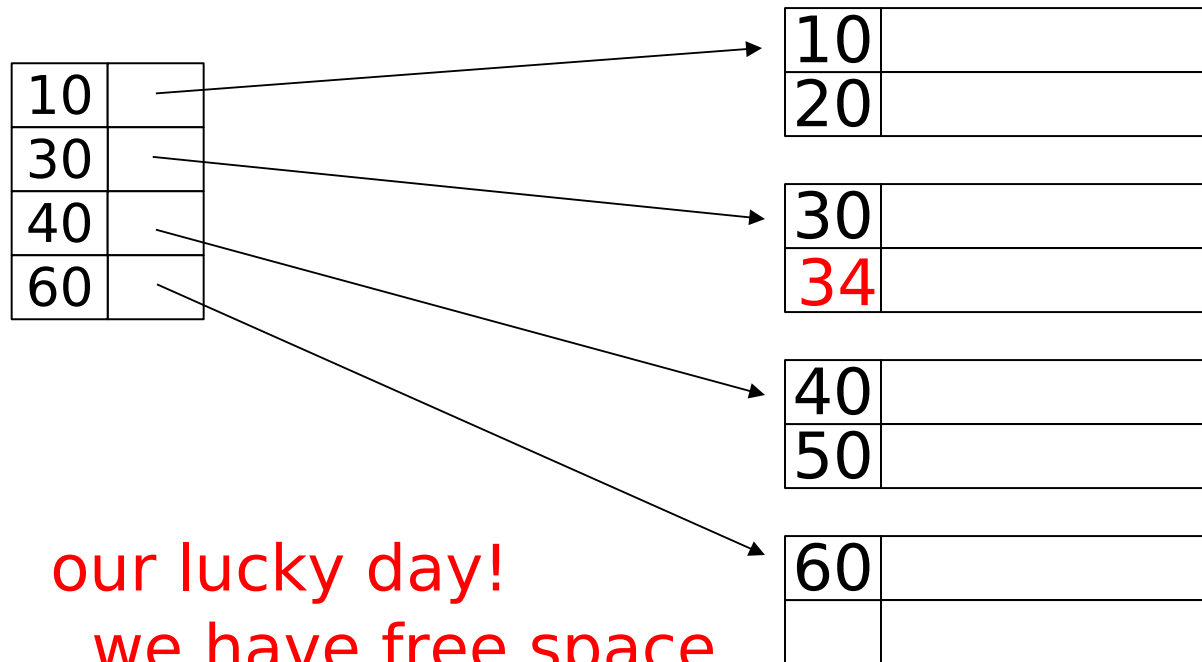

our lucky day!
we have free space
where we need it!

Insertion, sparse index case

- insert record 15

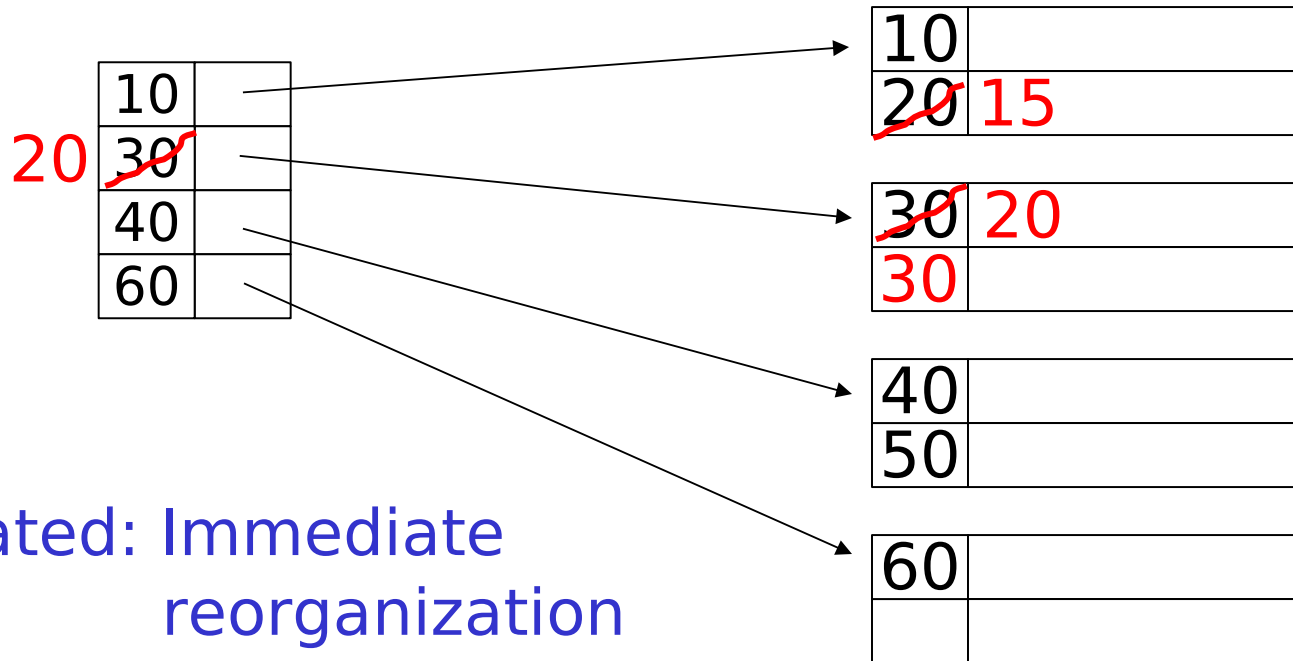

- Illustrated: Immediate reorganization
- Variation:
 - insert new block (chained file)
 - update index

Insertion, sparse index case

- insert record 25

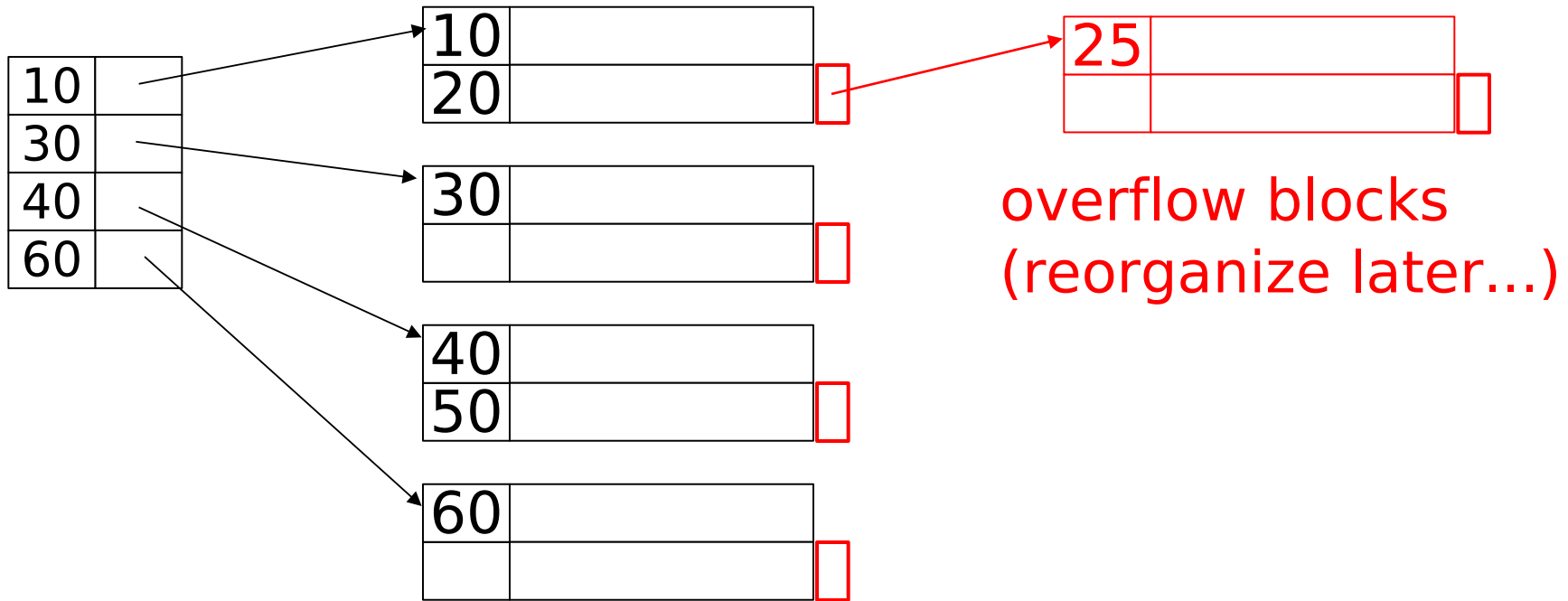

Insertion, dense index case

- Similar
- Often more expensive . . .

Secondary indexes

Sequence
field

30	
50	

20	
70	

80	
40	

100	
10	

90	
60	

Secondary indexes

- Sparse index

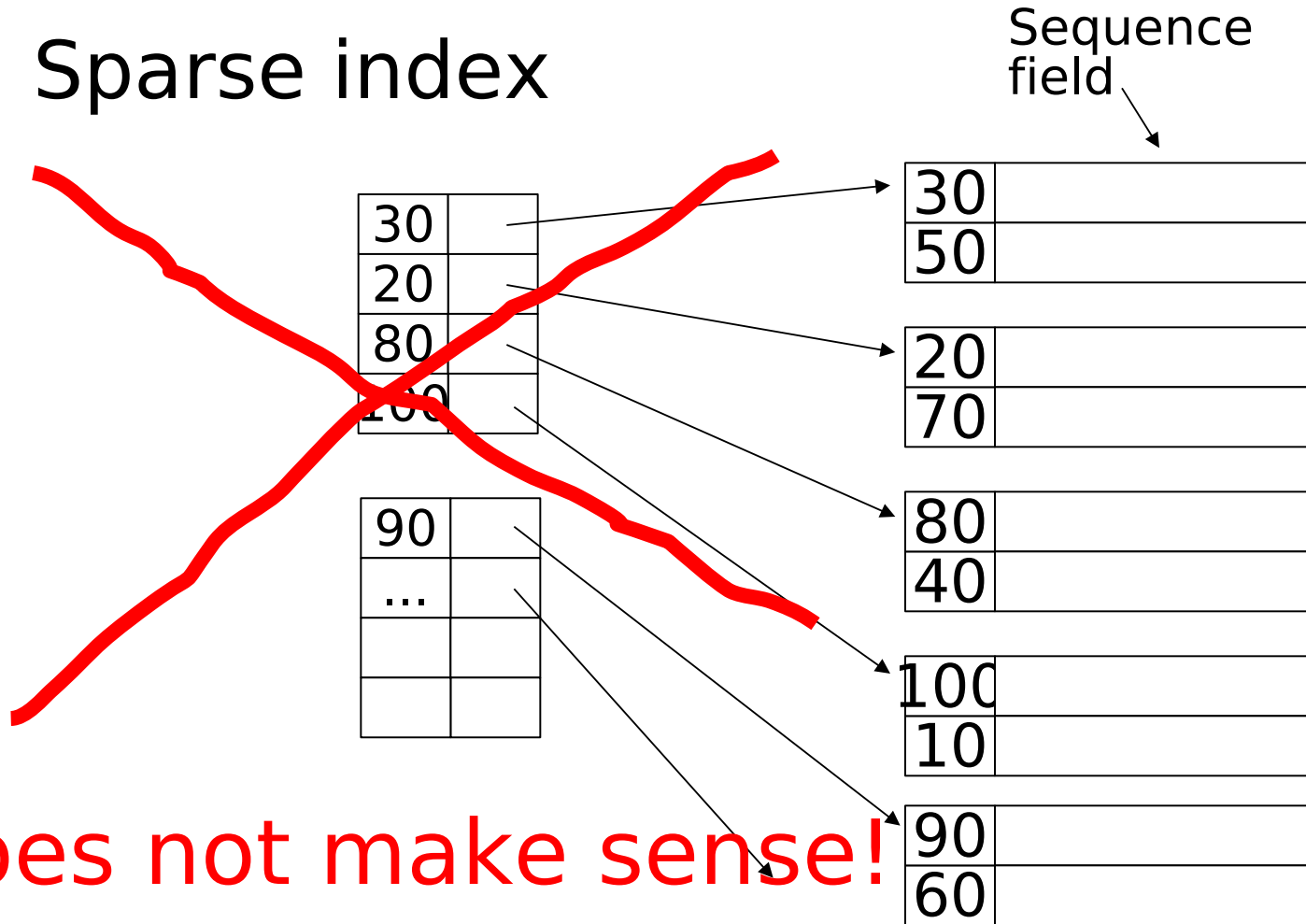

Secondary indexes

- Dense index

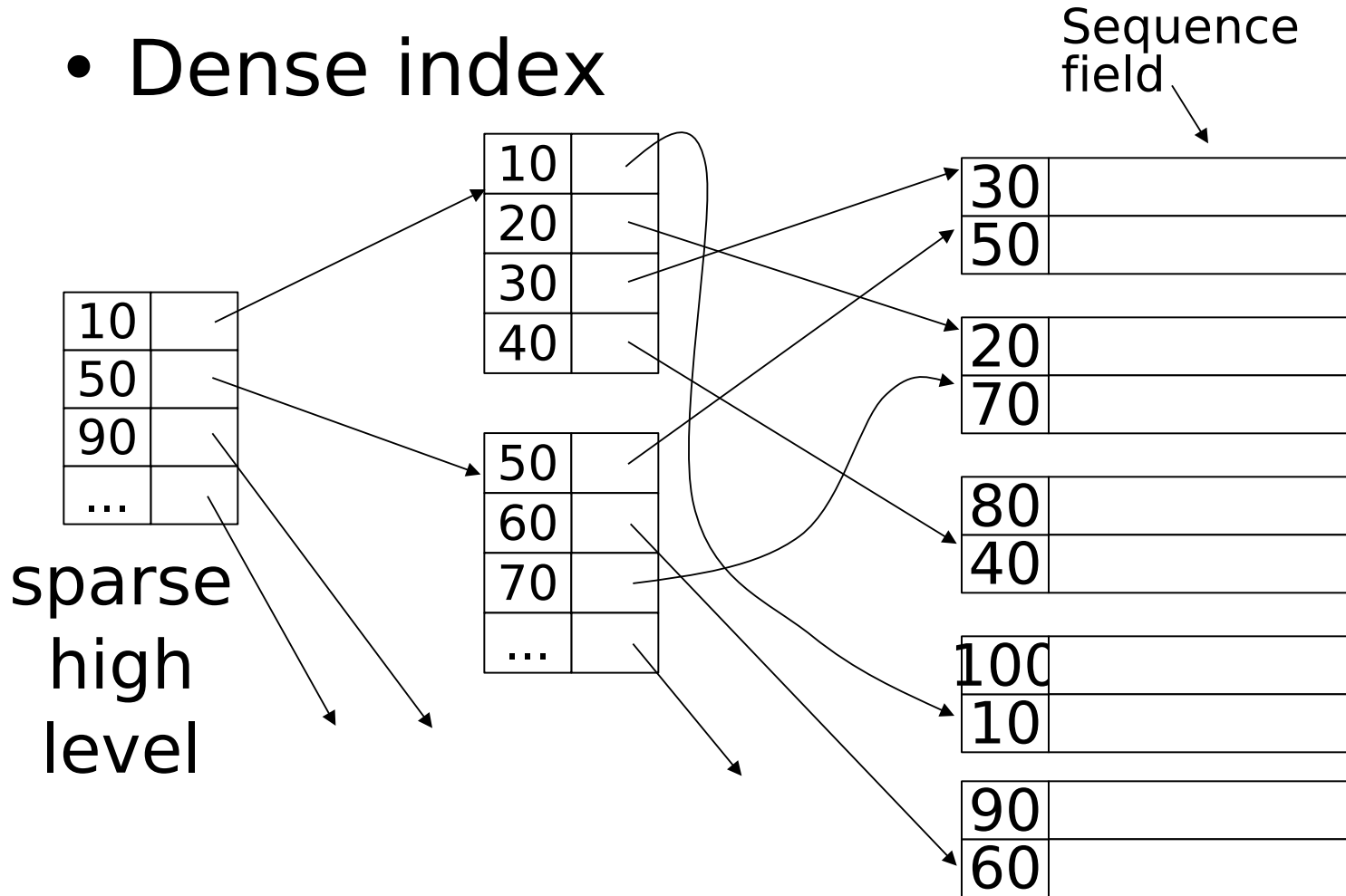

With secondary indexes:

- Lowest level is dense
- Other levels are sparse

Also: Pointers are record pointers
(not block pointers; not computed)

Duplicate values & secondary indexes

20	
10	

20	
40	

10	
40	

10	
40	

30	
40	

Duplicate values & secondary indexes

one option...

Problem:

excess overhead!

- disk space
- search time

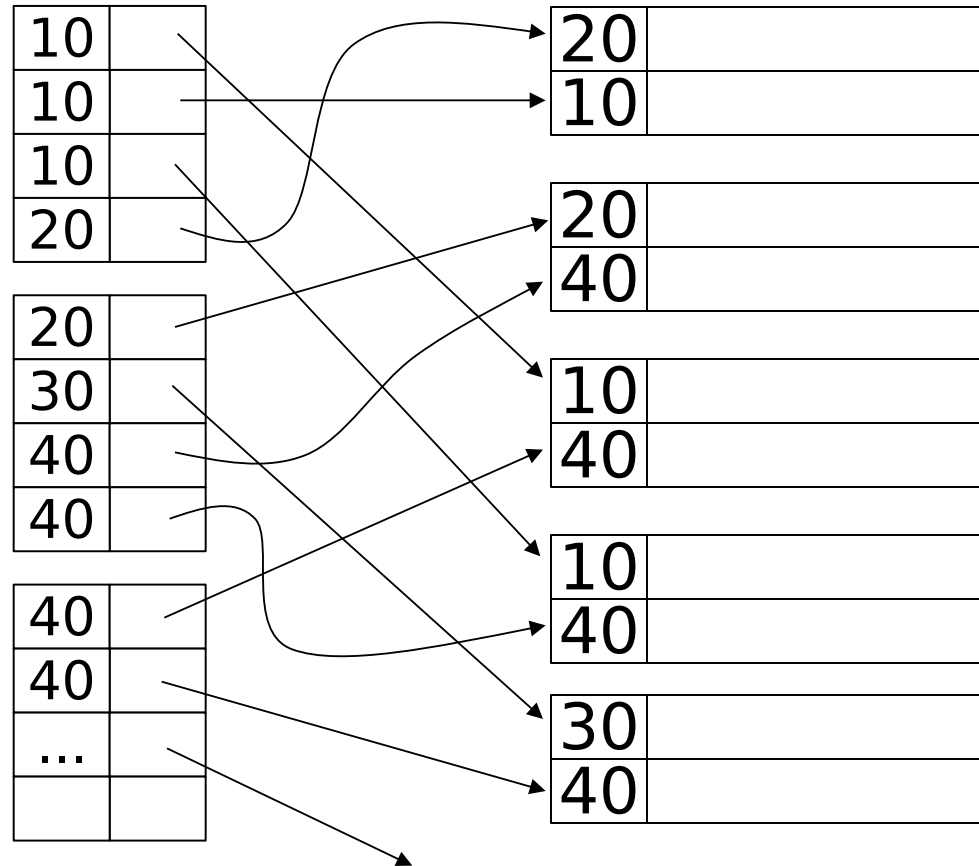

Duplicate values & secondary indexes

another option...

Problem:
variable size
records in
index!

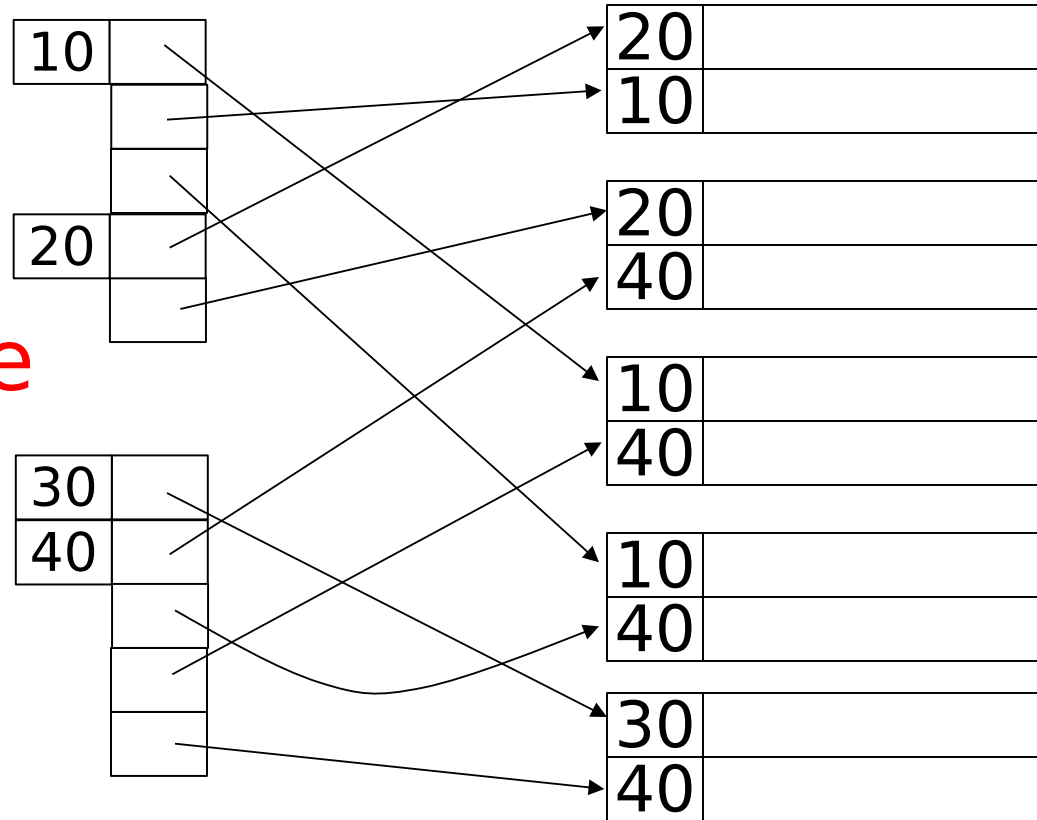

Duplicate values & secondary indexes

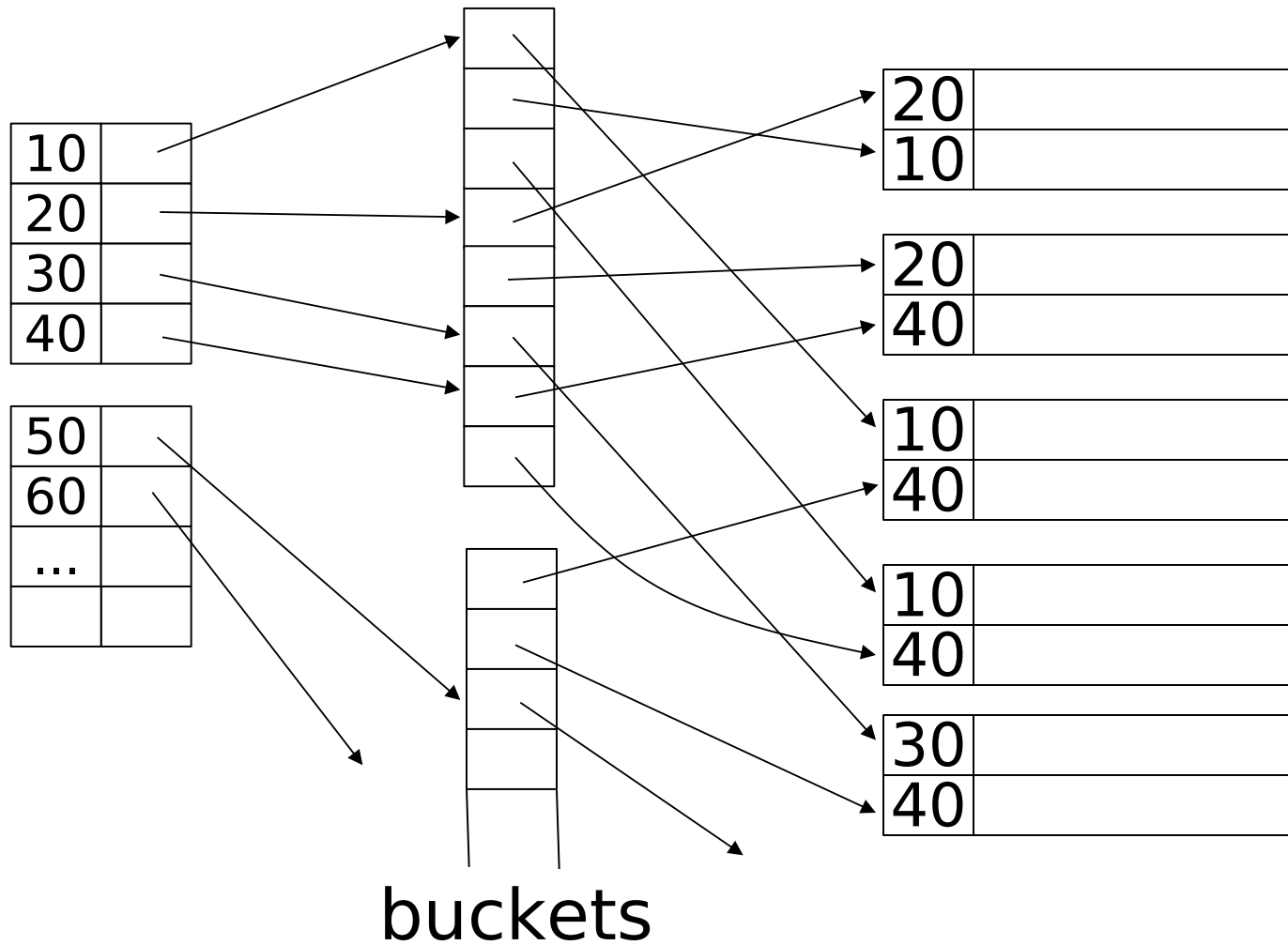

Why “bucket” idea is useful

Indexes

Name: primary

Dept: secondary

Floor: secondary

Records

EMP(name,dept,floor,...)

Query: Get employees in
(Toy Dept) \wedge (2nd floor)

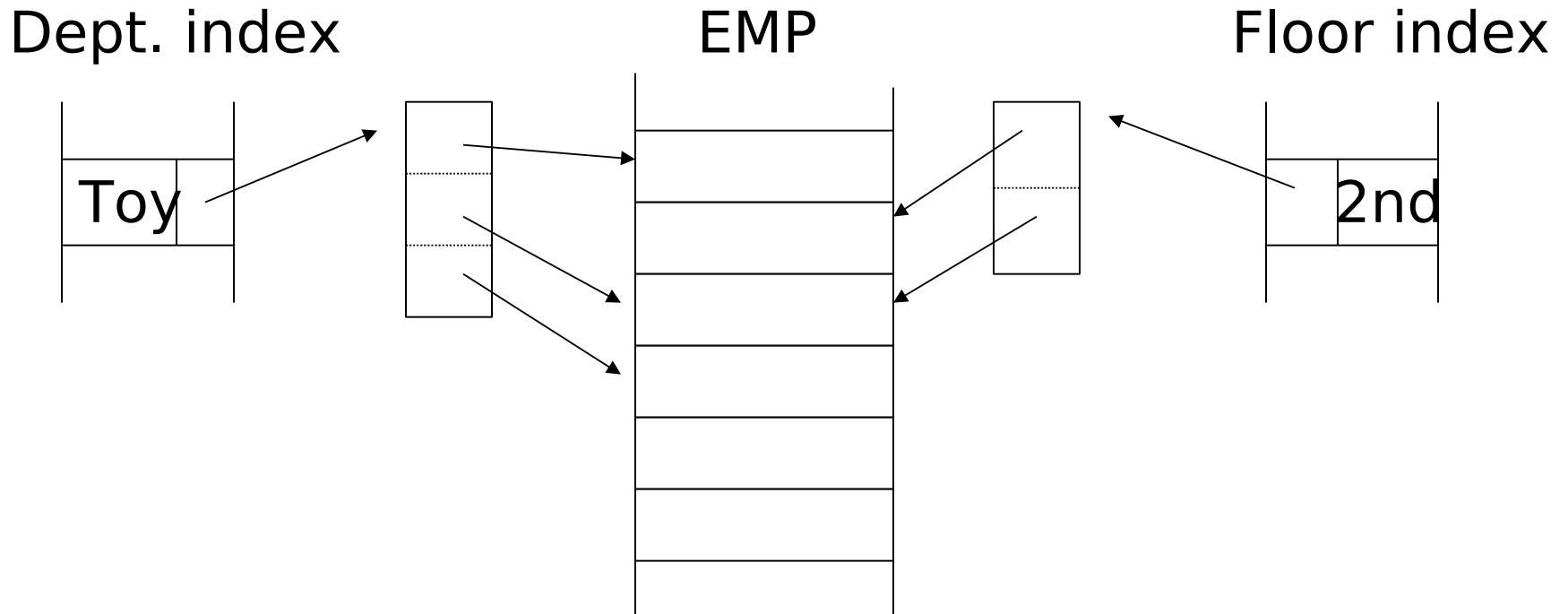

→ Intersect toy bucket and 2nd Floor

bucket to get set of matching EMP's

This idea used in text information retrieval

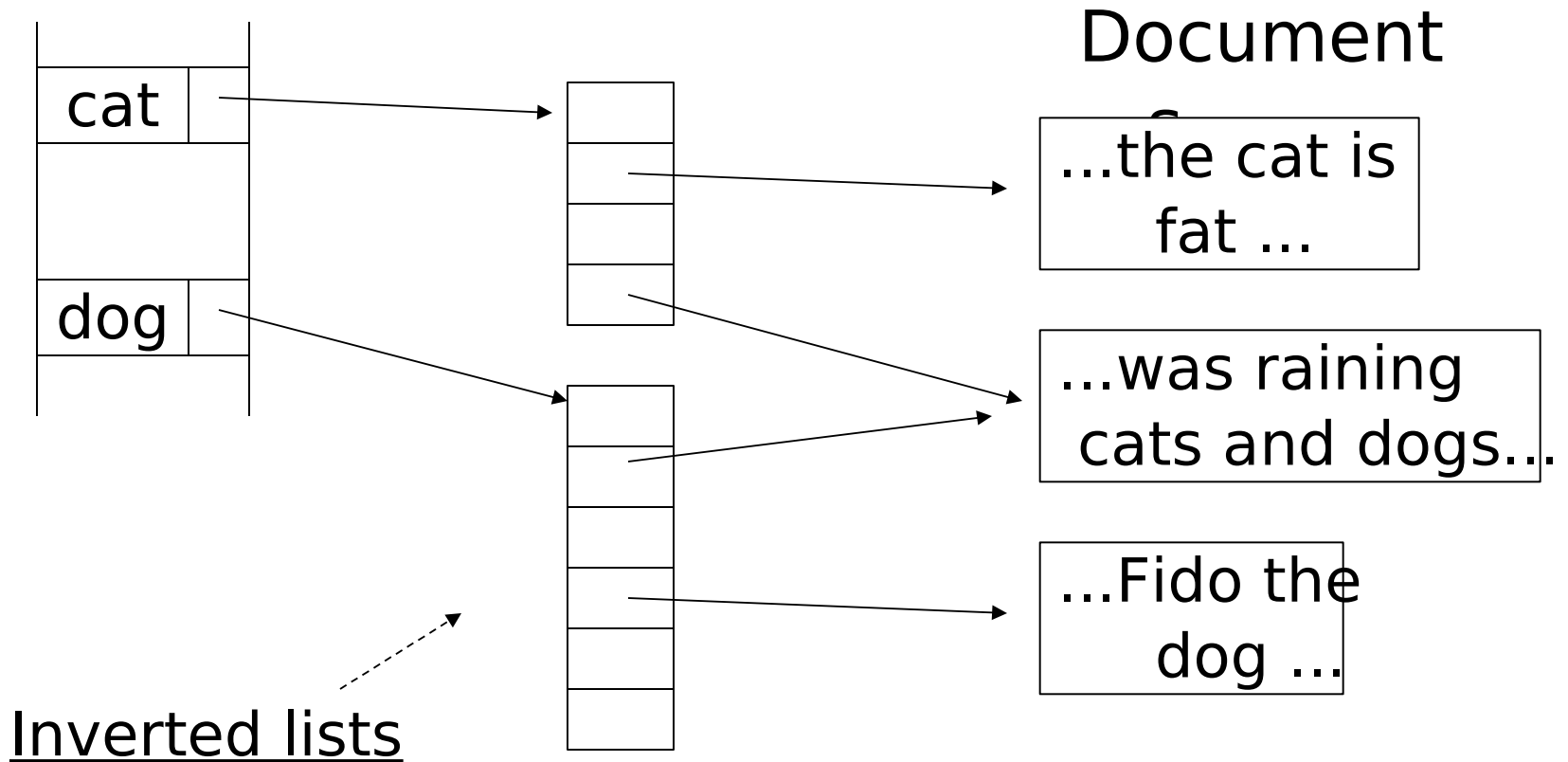

IR QUERIES

- Find articles with “cat” and “dog”
- Find articles with “cat” or “dog”
- Find articles with “cat” and not “dog”
- Find articles with “cat” in title
- Find articles with “cat” and “dog”
within 5 words

Summary so far

- Conventional index
 - Basic Ideas: sparse, dense, multi-level...
 - Duplicate Keys
 - Deletion/Insertion
 - Secondary indexes
 - Buckets of Postings List

Outline/summary

- Conventional Indexes
 - Sparse vs. dense
 - Primary vs. secondary
- B trees --> Next
 - B+trees vs. indexed sequential
- Hashing schemes

Conventional indexes

Advantage:

- Simple
- Index is sequential file
good for scans

Disadvantage:

- Inserts expensive, and/or
- Lose sequentiality & balance

Example

Index (sequential)

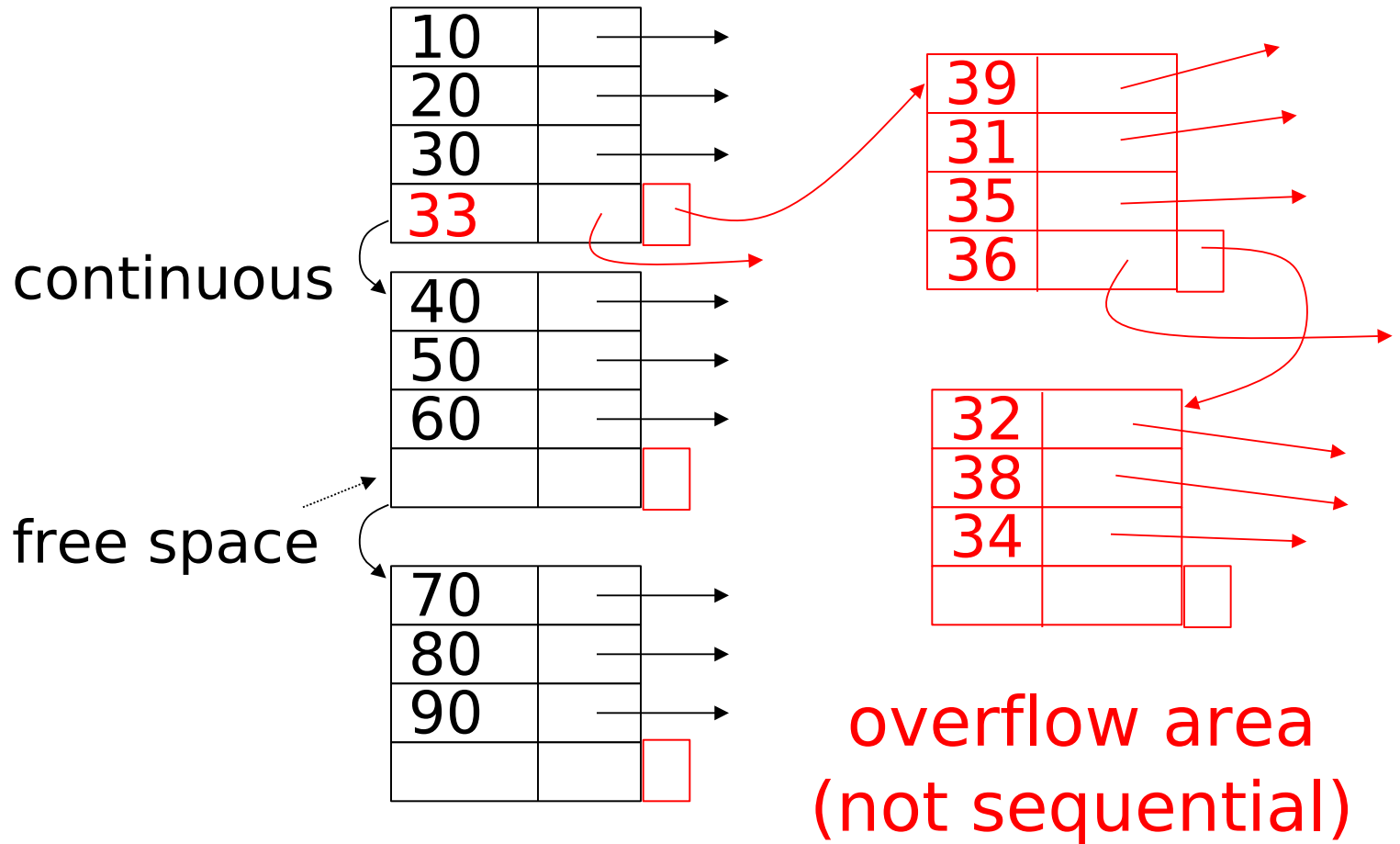

- NEXT: Another type of index
 - Give up on sequentiality of index
 - Try to get “balance”

B+Tree Example

n=3

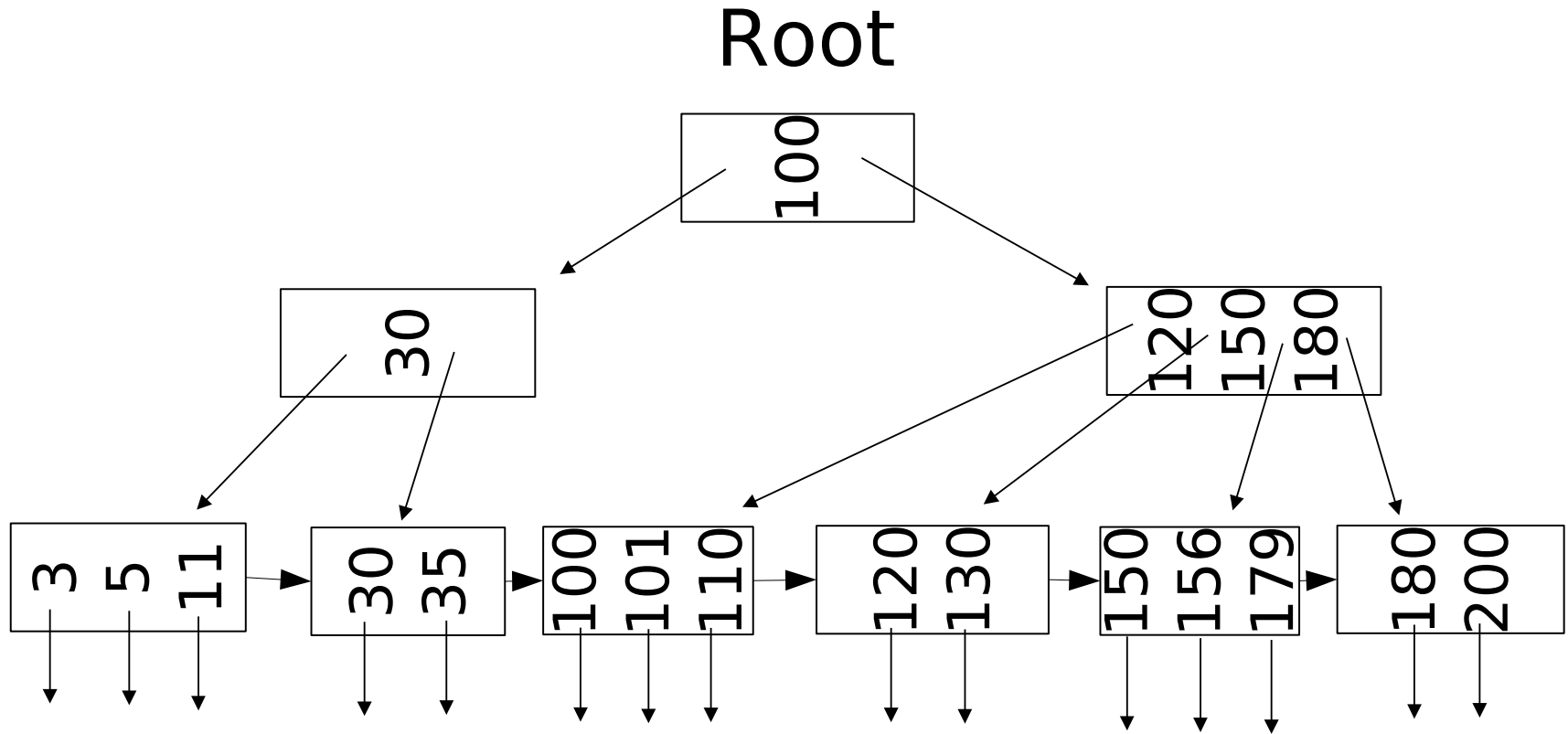

Sample non-leaf

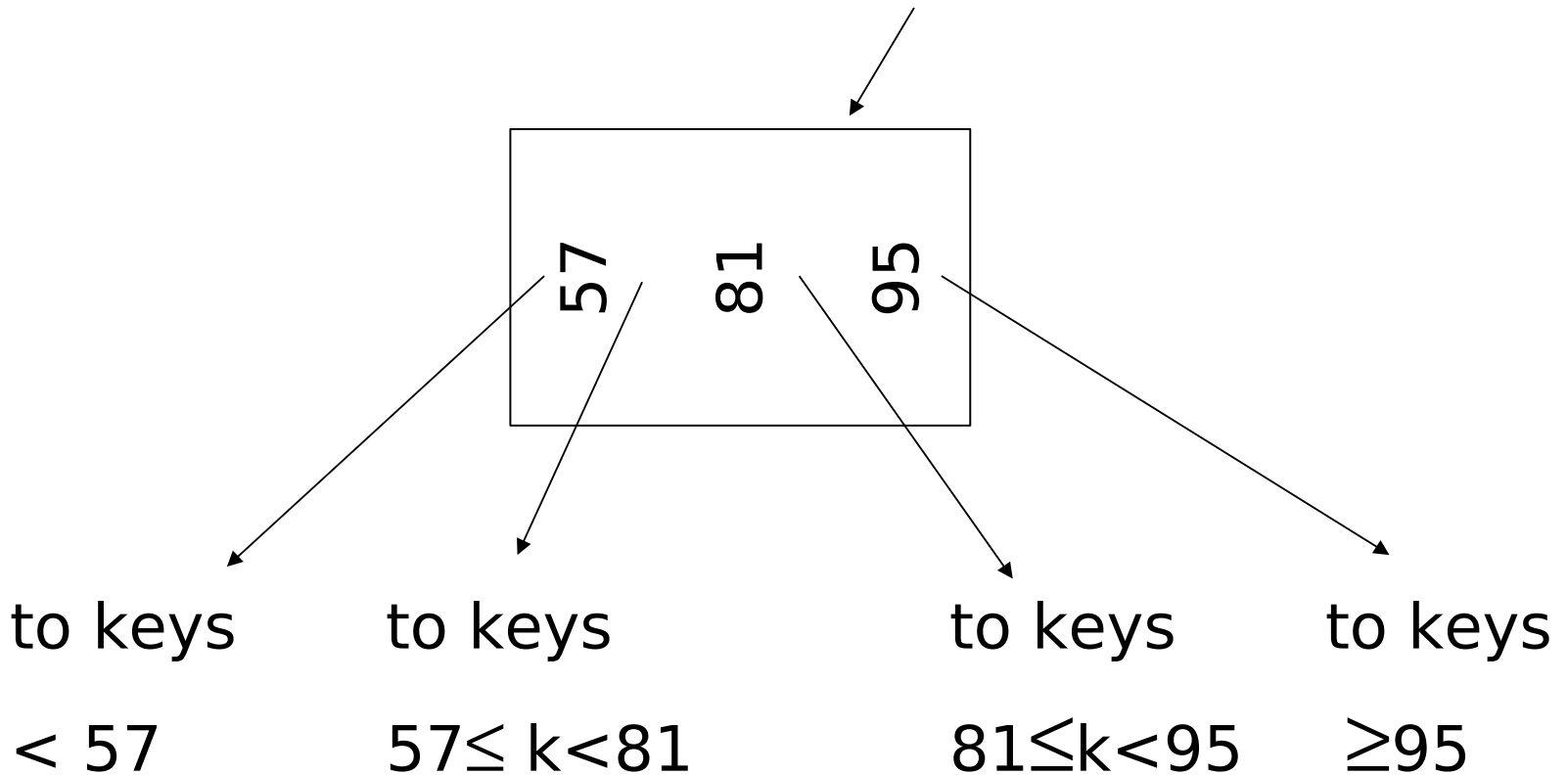

Sample leaf node:

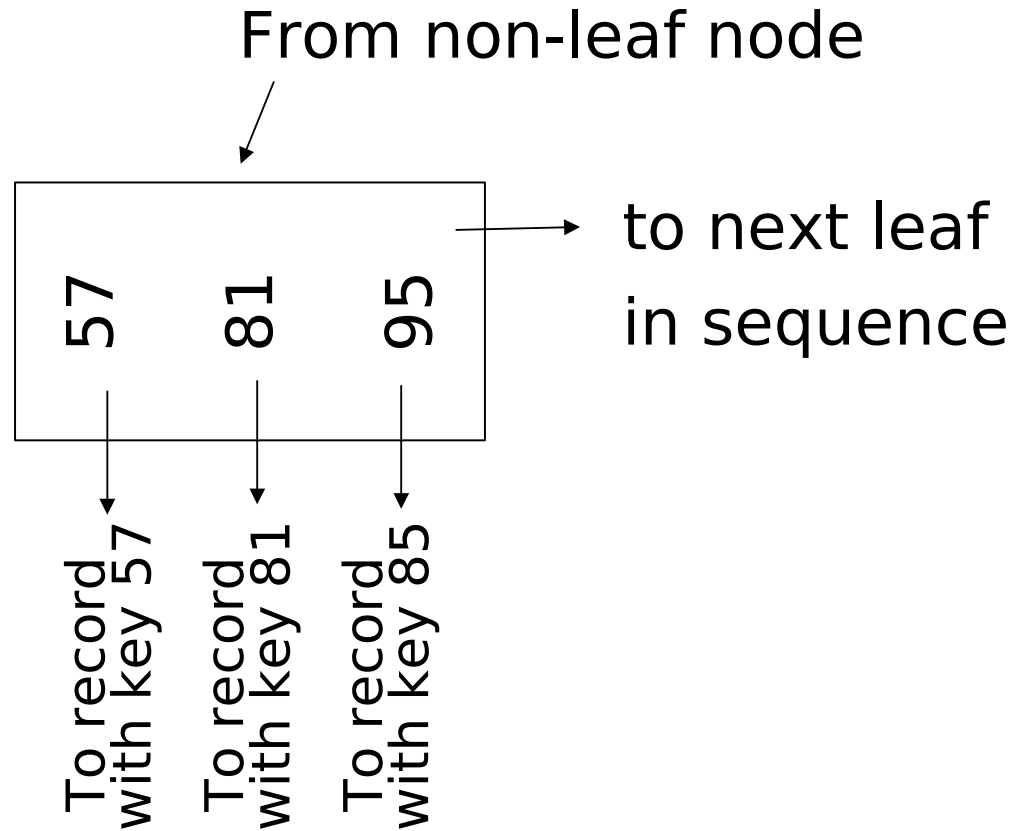

In textbook's notation

$n=3$

Leaf:

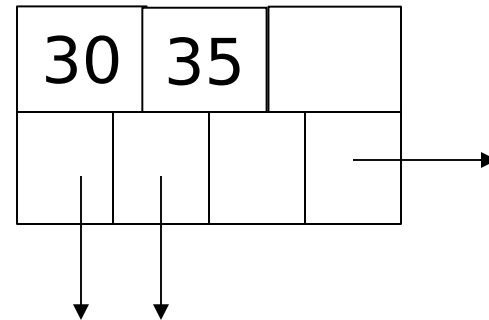
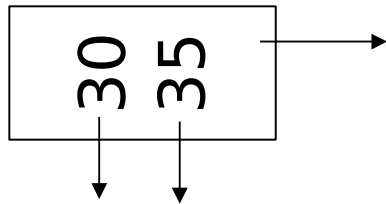

Non-leaf:

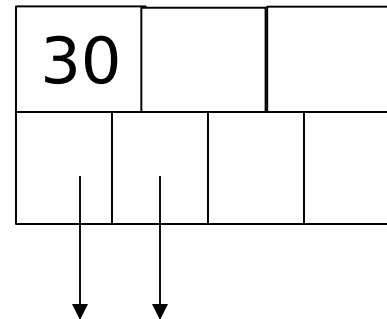
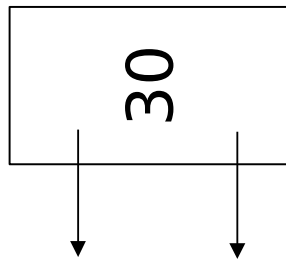

Lookup record(s) with key = 35

n=3

Root

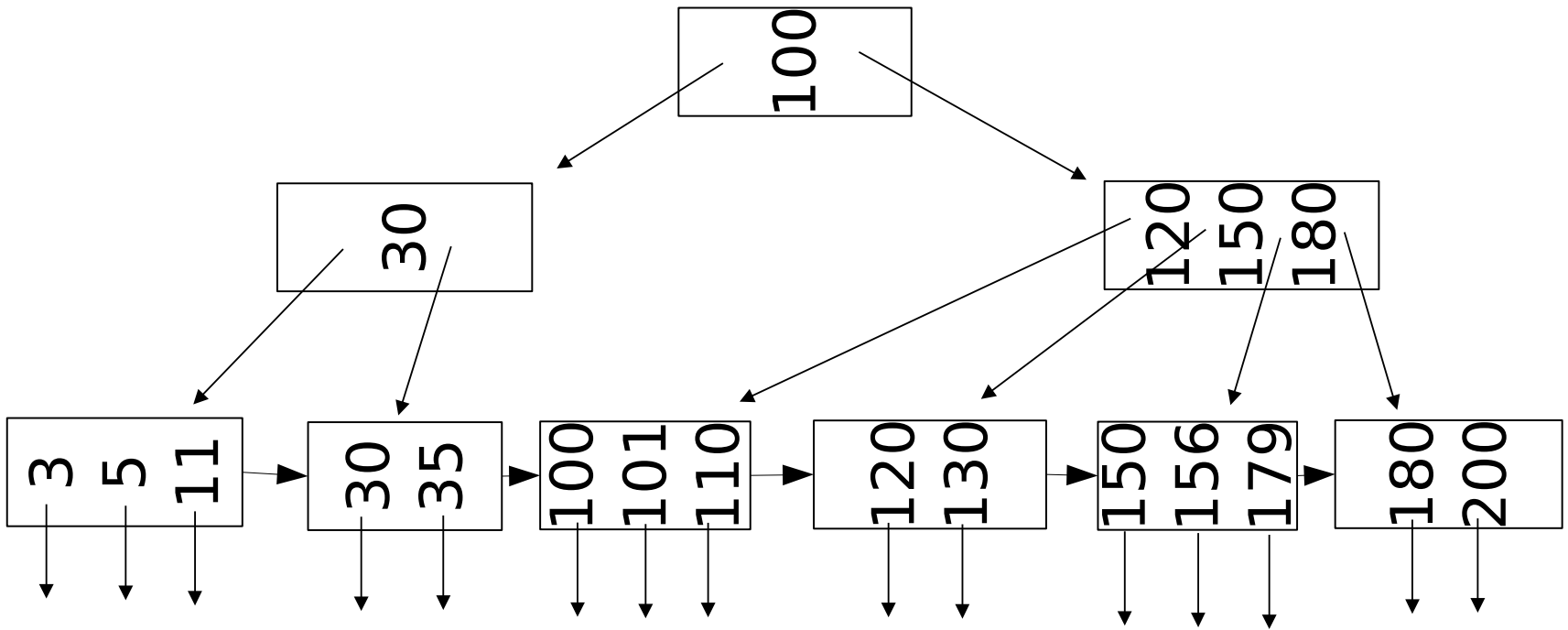

Lookup record(s) with key = 40

n=3

Root

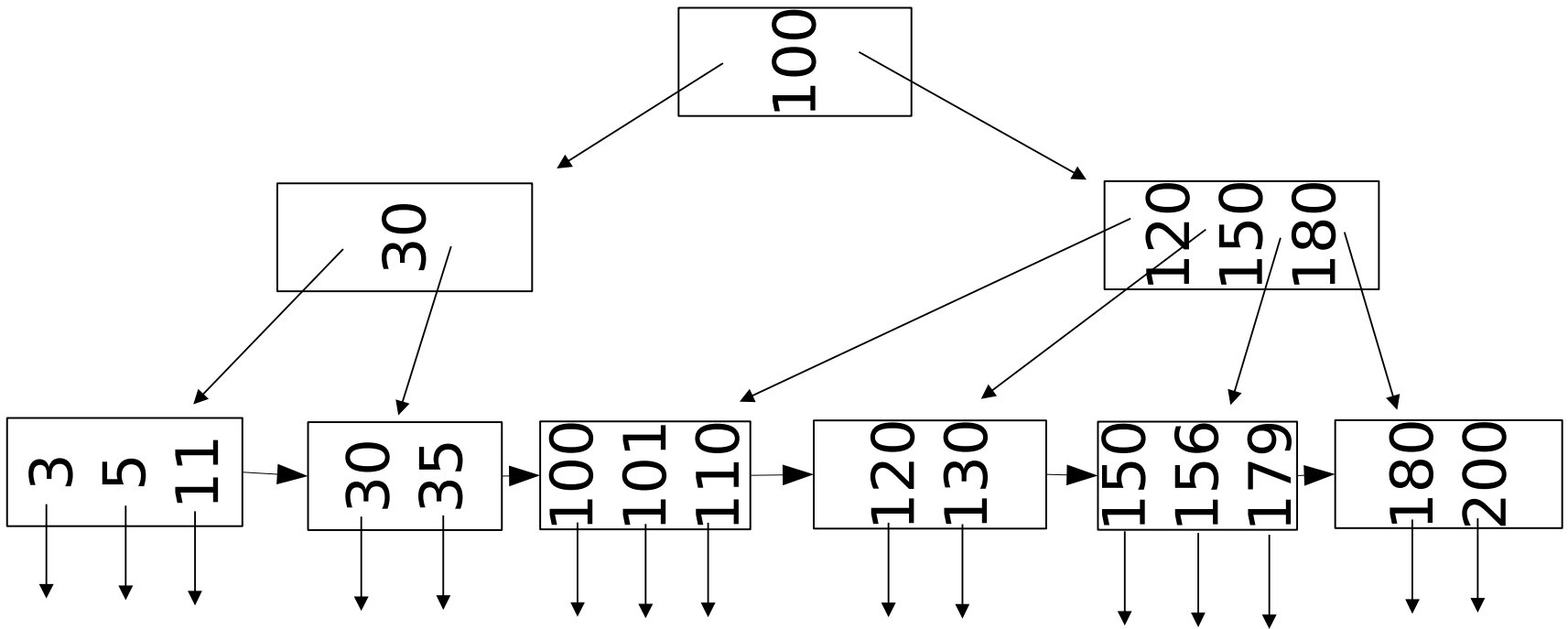

Range query: lookup record(s)
with $35 \leq \text{key} \leq 150$

$n=3$

Root

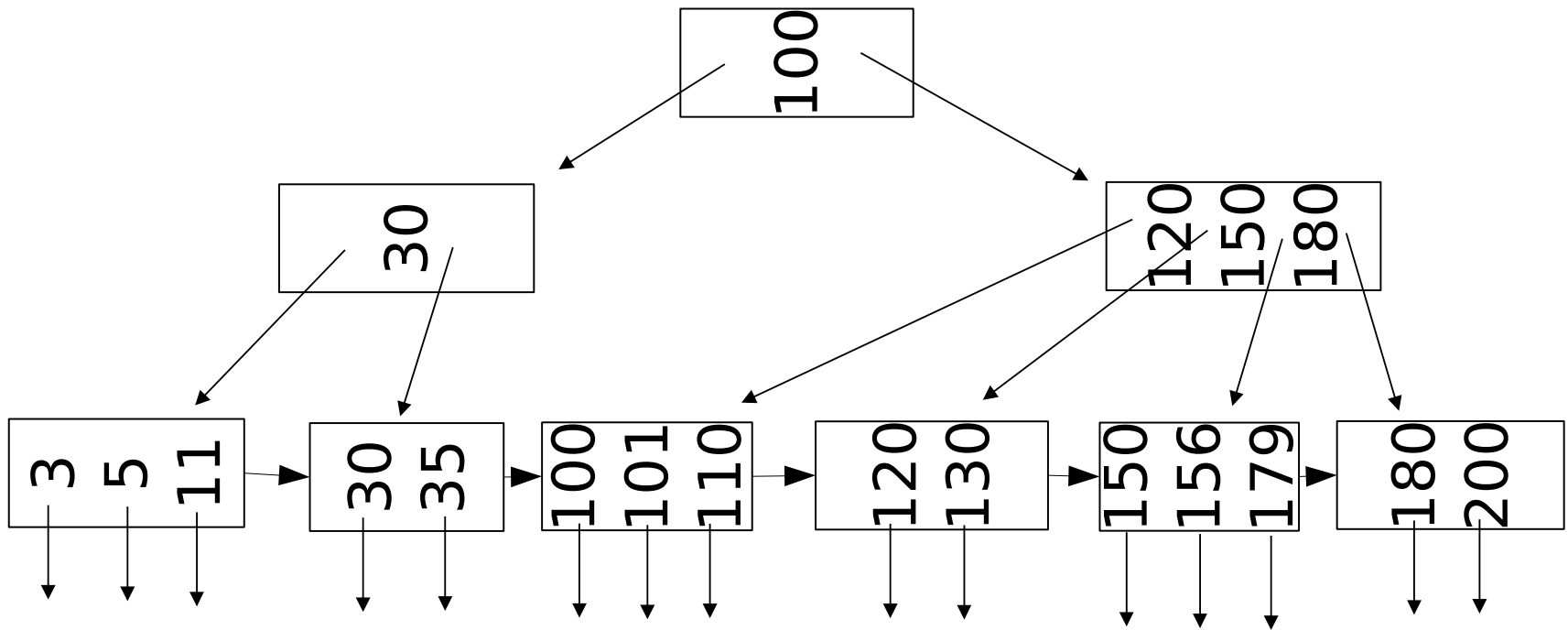

- The I/O cost of a lookup in a BTree is equal to longest path of the root to a leaf
- Hence, the goal is to keep this longest path as short as possible
- In particular: we want all leafs to be at the same depth in the tree (and hence want a balanced tree)

Size of nodes: { n+1 pointers
n keys (fixed)

Don't want nodes to be too empty

- Use at least

Non-leaf: $\lceil (n+1)/2 \rceil$ pointers

Leaf : $\lfloor (n+1)/2 \rfloor$ pointers to data

n=3

node
Non-leaf

Full node

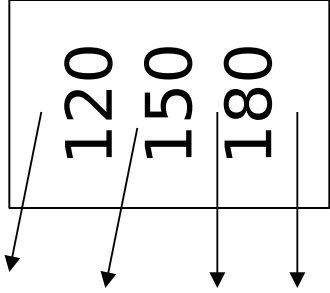

min.

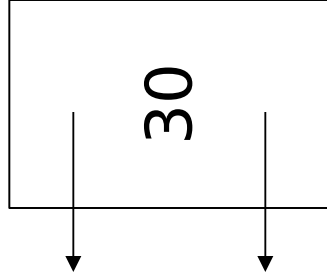

Leaf

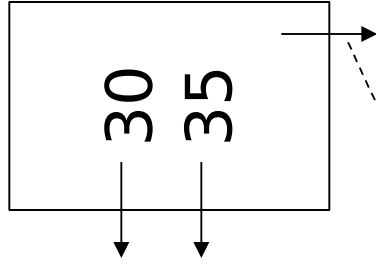
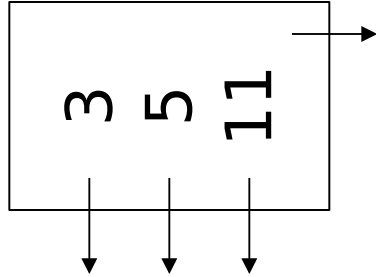

counts even if null

B+tree rules

tree of order d

- (1) All leaves at same lowest level
(balanced tree)
- (2) Pointers in leaves point to records except for “sequence pointer”

(3) Number of pointers/keys for B+tree

	Max ptrs	Max keys	Min ptrs → data	Min keys
Non-leaf (non-root)	$n+1$	n	$\lceil (n+1)/2 \rceil$	$\lceil (n+1)/2 \rceil - 1$
Leaf (non-root)	$n+1$	n	$\lfloor (n+1)/2 \rfloor$	$\lfloor (n+1)/2 \rfloor$
Root	$n+1$	n	2	1

Insert into B+tree

- (a) simple case
 - space available in leaf
- (b) leaf overflow
- (c) non-leaf overflow
- (d) new root

(a) Insert key = 32

n=3

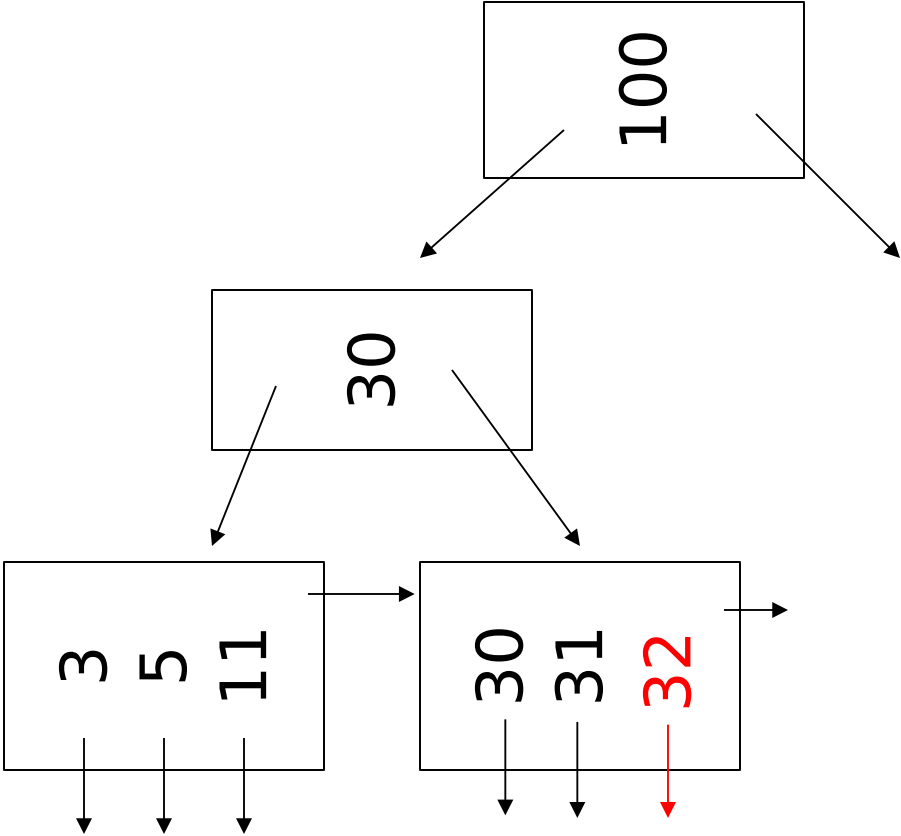

(a) Insert key = 7

n=3

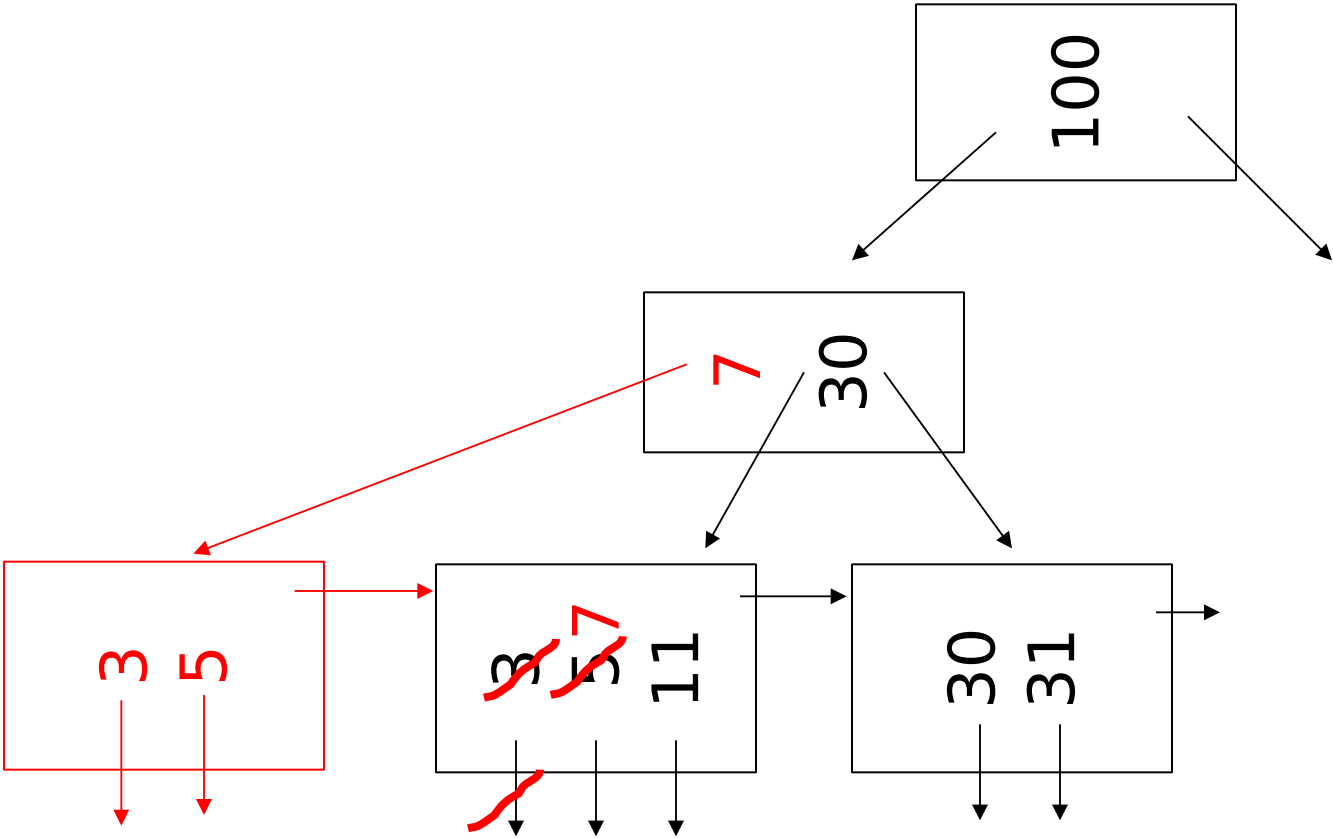

(c) Insert key = 160

n=3

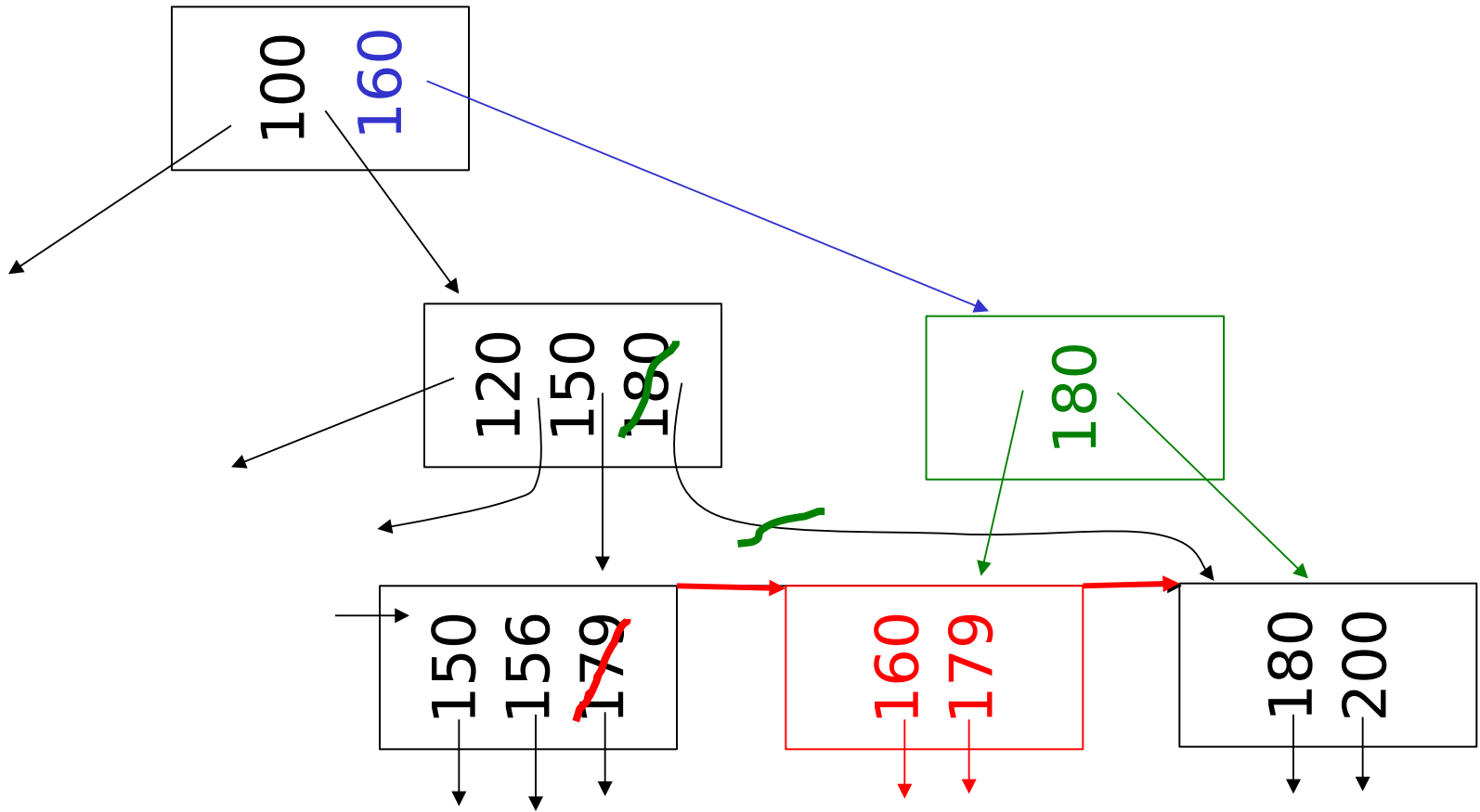

(d) New root, insert
45

n=3

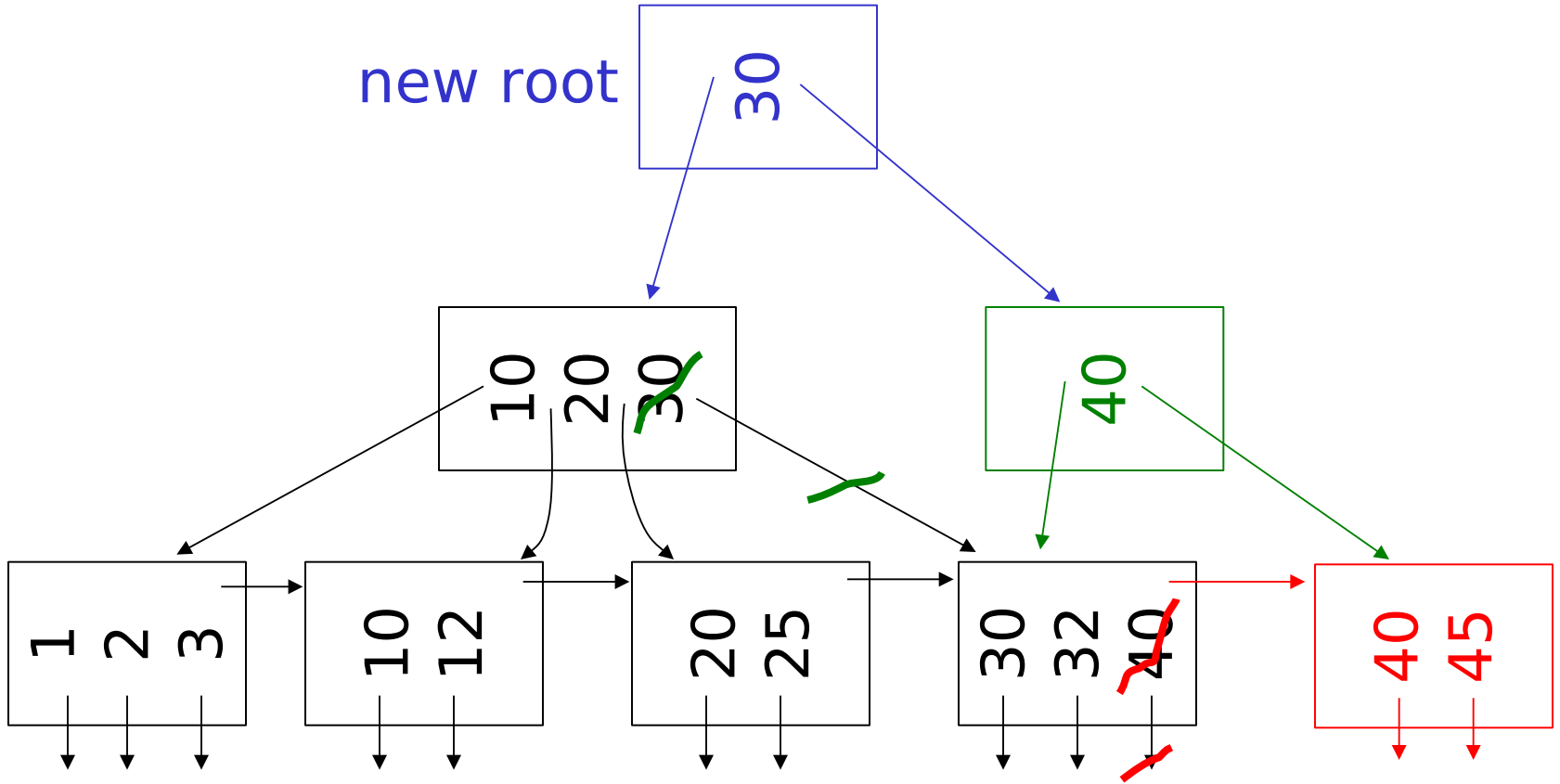

Deletion from B+tree

- (a) Simple case - no example
- (b) Coalesce with neighbor (sibling)
- (c) Re-distribute keys
- (d) Cases (b) or (c) at non-leaf

(b) Coalesce with sibling

- Delete 50

n=4

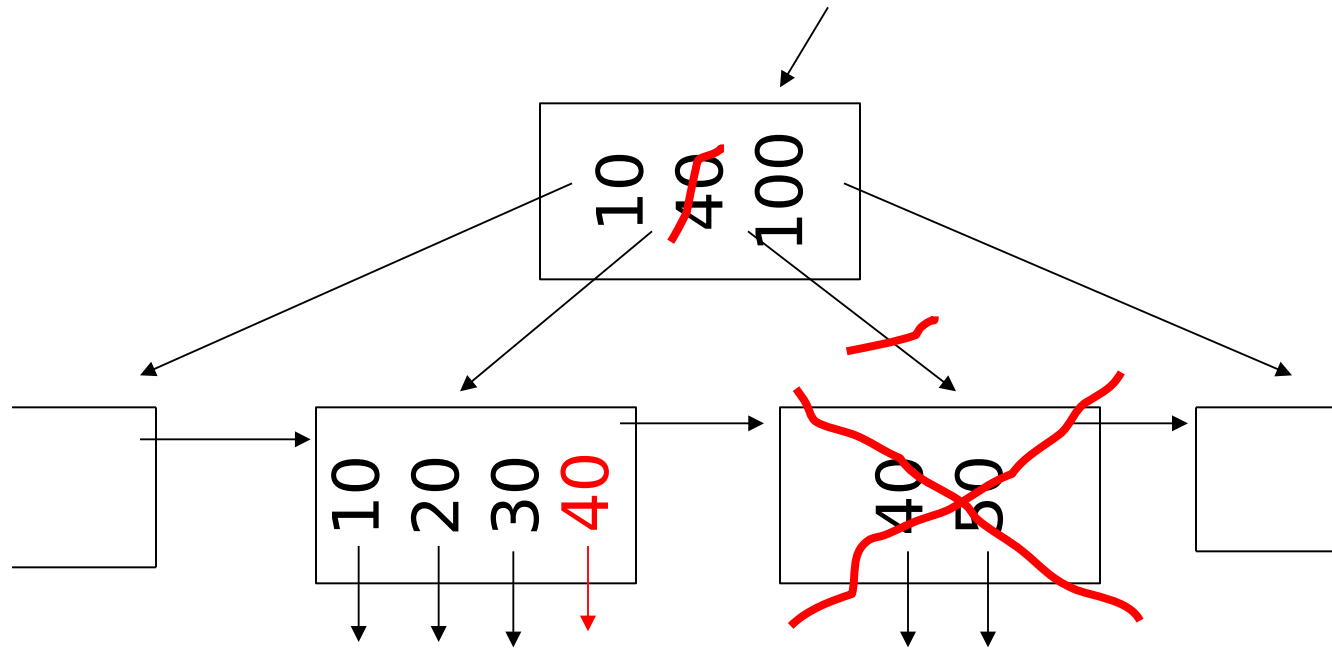

(c) Redistribute keys

- Delete 50

n=4

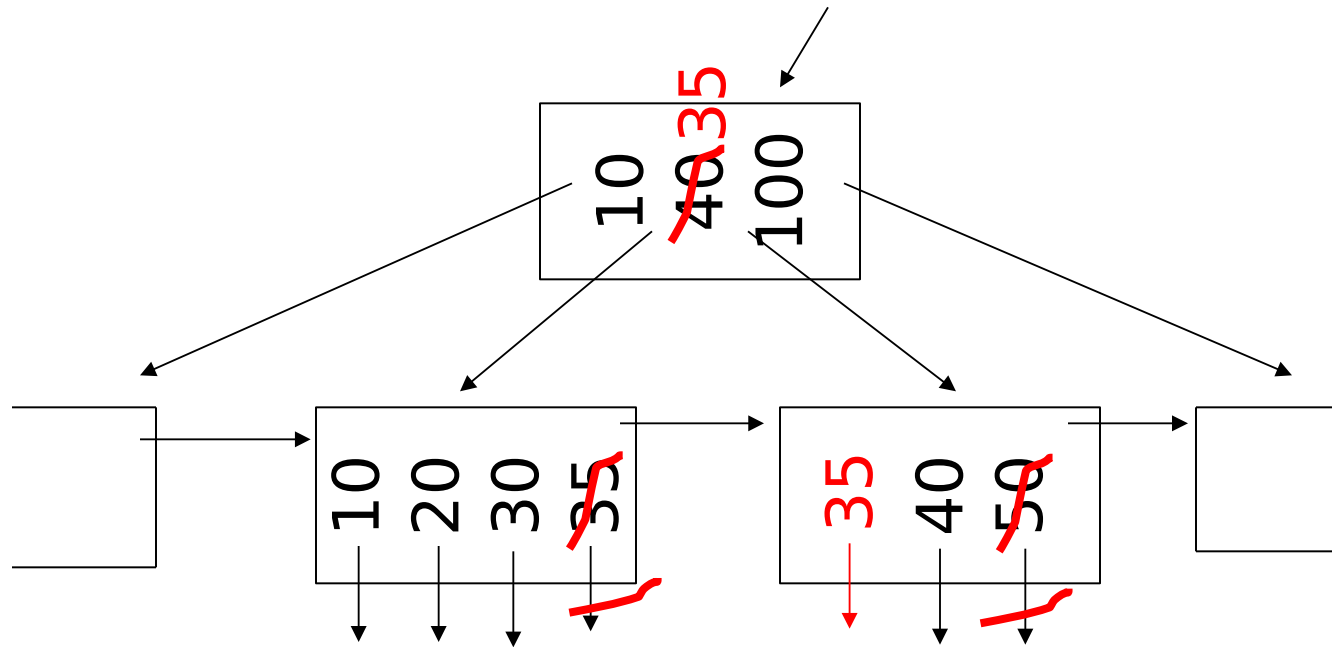

(d) Non-leaf coalesce

- Delete 37

n=4

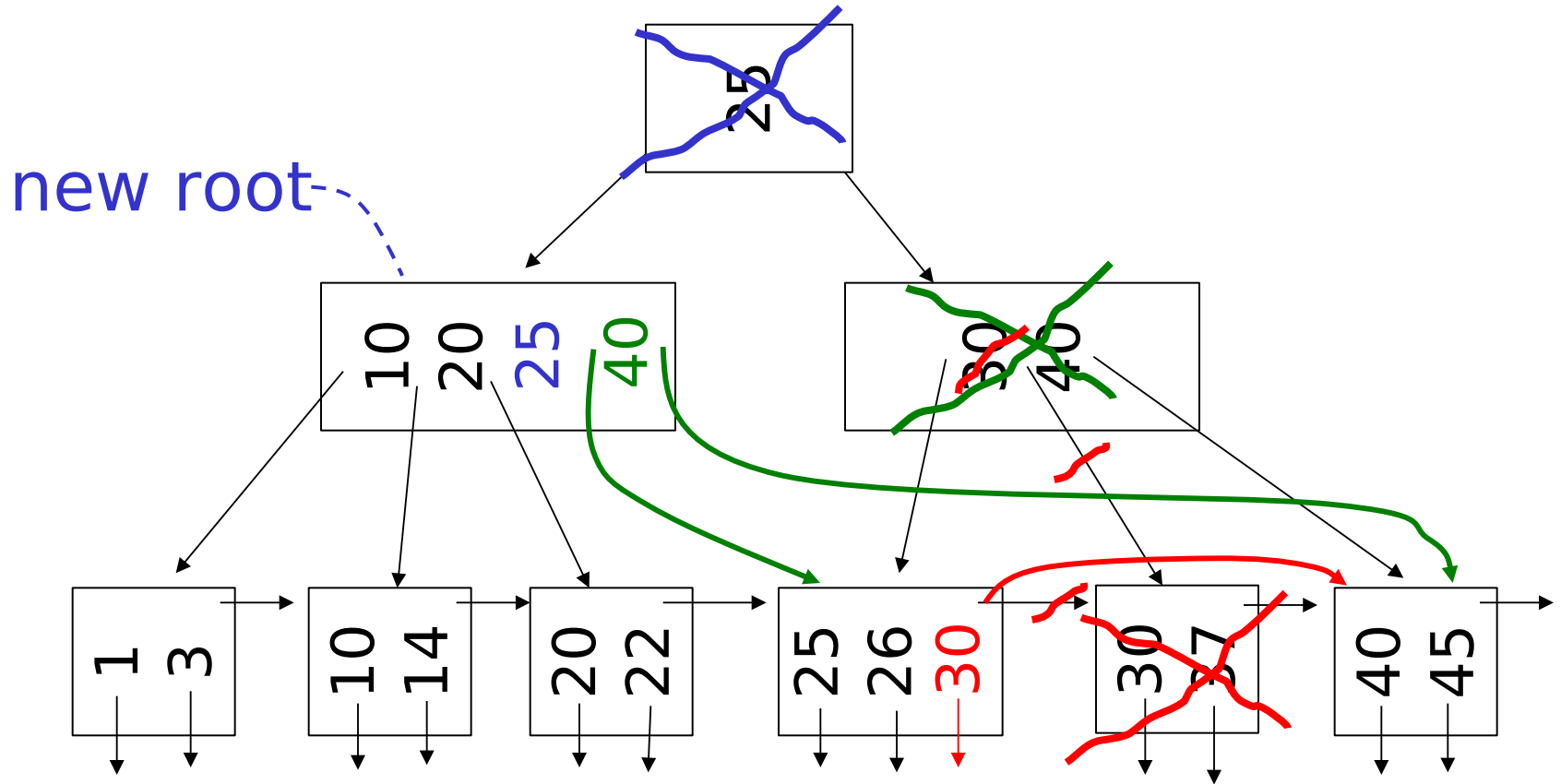

Outline/summary

- Conventional Indexes
 - Sparse vs. dense
 - Primary vs. secondary
- B trees
 - B+trees vs. indexed sequential
- Hashing schemes --> Next